

COWELL IMPLANT SYSTEM

Help your daily practice superior



INNO Submerged

Cowellmedi's flagship implant designed for immediate placement, immediate loading, adjustable placement depth, and use in a wide variety of cases, including maxillary sinus applications.



INNO Submerged Narrow

Ideal for narrow alveolar ridges in the anterior region. Features double tapered threads that provide enhanced primary stability through wedge action.

**COWELL®
IMPLANT
SYSTEM**



INNO X / V

Innovative implants from Cowellmedi featuring a unique trapezoid buttress thread and wide, deep body threads, delivering superior initial fixation and stability in all bone types. Optimized for immediate placement and diverse clinical cases.

COWELL IMPLANT SYSTEM

Help your daily practice superior



INNO Submerged Short

Designed for severe bone resorption. Wide and deep upper threads prevent the compressive necrosis of the cortical bone.



INNO Internal

4 spiral round cutting edges maximize the efficiency of self-tapping with a sharp edge and accommodate bone chips as ideal cutting edge pocket space.

**COWELL®
IMPLANT
SYSTEM**



INNO External

The platform neck with open thread aids in the stable engraftment of the periosteum at the bone-implant interface.



Mini Plus

Designed for mandible anterior spaces and edentulous arch. Semi-permanent or temporary solution for anterior spaces with the extremely narrow ridge.

INNO Implant Design

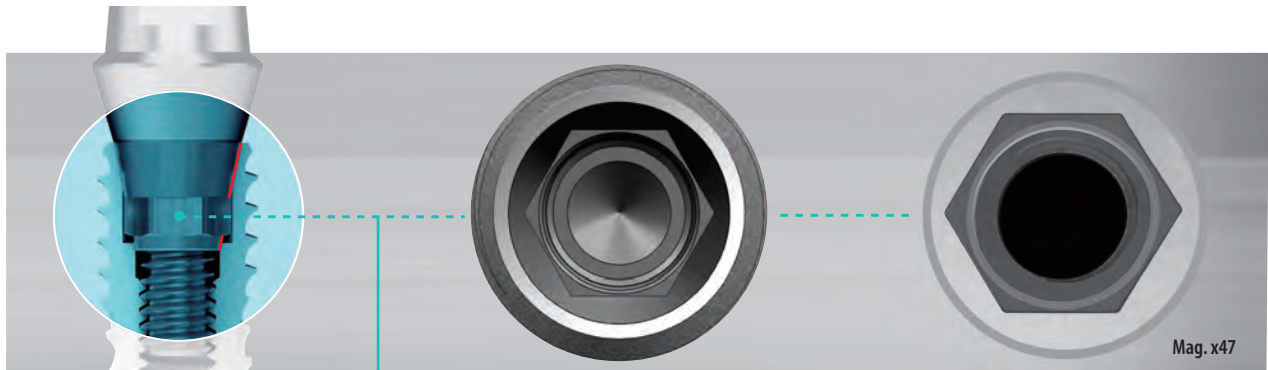

Tapered Hex Connection with Double Contacts

- > Allows for an ideal cold welding between the fixture and abutment.
- > Prevents micro-sinking of the abutment.
- > Minimizes micromovement and distribute stress against loading.

Wide and Deep Upper Threads

- > Prevent the compressive necrosis of the cortical bone.
- > Minimize the need for countersink drills.
- > Increase the mechanical strength by reinforcing the thickness.

Double Tapered Threads

- > Ensure initial stability even in areas with poor bone quality or alveolar socket.
- > Allow the fixture inserted more than half its length into the drilled hole to be placed in only 2 to 4 turns.
- > Achieve higher primary stability with wedge action, even with an additional half turn.

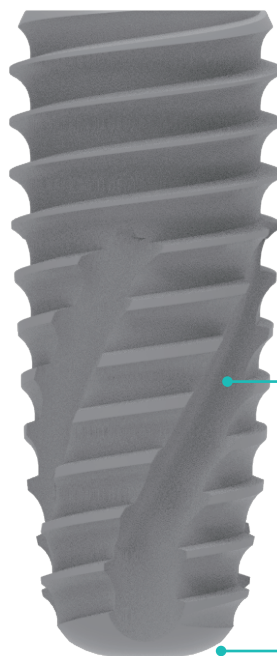

Platform Neck

- > Enables stable engraftment of the periosteum at the interface between bone and implant.

Open Threads

- > Allow the fixture to be placed deeper without additional drilling.

4 spiral round cutting edges

- > Maximize the efficiency of self-tapping with sharp edges.
- > Allow for smooth placement of the fixture but provide higher initial stability (see test table below).

Concave Apex Threads with Sharp Cutting Edges

- > Prevent Schneiderian membrane from being ripped.
- > Enhance initial stability of the fixture in extraction sockets.

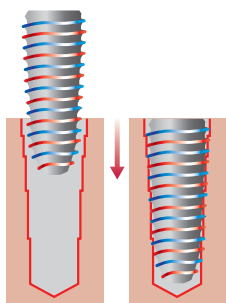

Shortens the placement time with 5mm or more of already entered depth as well as double thread.



※ Comparison of the average placement torque force of 4 different fixtures (4pcs each) with dimensions of Ø4.5X10mm in 5.0 and 5.5mm deep holes of type 2 bone quality test block.

Classification	INNO	A	B	C
Depth:5.0mm	28622Ncm	29922Ncm	28689Ncm	28894Ncm
Depth 5.5mm	44.0 Ncm	38.0 Ncm	34.4 Ncm	38.5 Ncm

INNO X Implant Design

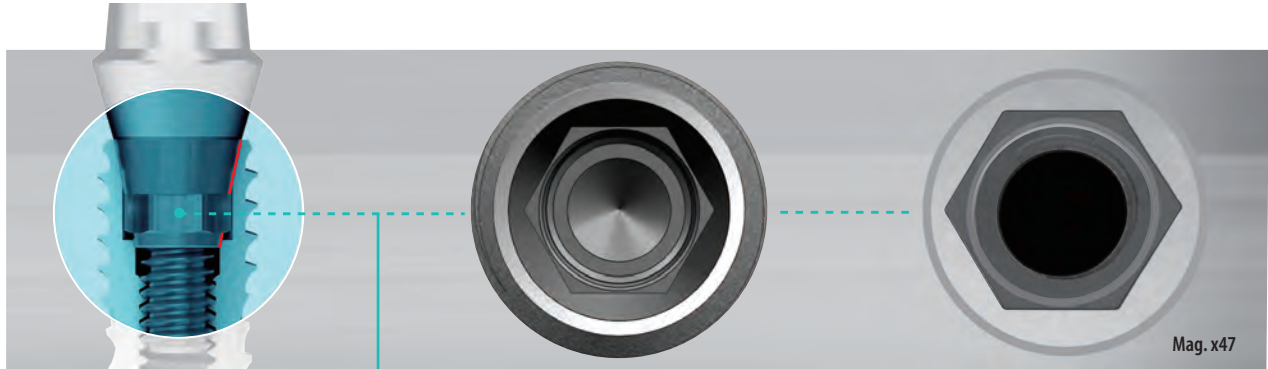

Tapered Hex Connection with Double Contacts

- > Allows for an ideal cold welding between the fixture and abutment.
- > Prevents micro-sinking of the abutment.
- > Minimizes micromovement and distribute stress against loading.

Wide and Deep Upper Threads

- > Prevent the compressive necrosis of the cortical bone.
- > Minimize the need for countersink drills.
- > Increase the mechanical strength by reinforcing the thickness.

Double Tapered Threads

- > Ensure initial stability even in areas with poor bone quality or alveolar socket.
- > Allow the fixture inserted more than half its length into the drilled hole to be placed in only 2 to 4 turns.
- > Achieve higher primary stability with wedge action, even with an additional half turn.

2 Spiral Round Cutting Edges

- > Maximizes self-tapping efficiency with sharp edges.
- > Ideal cutting-edge pocket design accommodates bone chips effectively.

Platform Neck

- > Enables stable engraftment of the periosteum at the interface between bone and implant.
- > Prevents inflammation around the implant.
- > Reduces stress on crestal bone, minimizing crestal bone loss.

Open Threads

- > Allow the fixture to be placed deeper without additional drilling.

Wide & Deep Body Thread

- > Deep and wide threads (0.9 pitch) increase the functional surface area at the bone-implant interface, enhancing primary stability in low-density bone or high occlusal load areas.

2 Flat Cutting Edge

- > Minimizes pressure on the gingival bone and improves self-tapping ability.

Flat Apex Thread

- > Provides initial fixation at the lower drill end.
- > Suitable for immediate placement in extraction sockets.
- > Facilitates favorable stress distribution to surrounding bone.



- > 2 Spiral Round Cutting Edges
- > 2 Flat Cutting Edge

Trapezoid Buttress thread

- > A unique design by Cowellmedi combining a basic trapezoid shape with a reverse buttress structure, ensuring optimal primary fixation in any bone quality from D1 to D4. Minimizes bone compression from compressive force and provides excellent stress distribution.

INNO V Implant Design

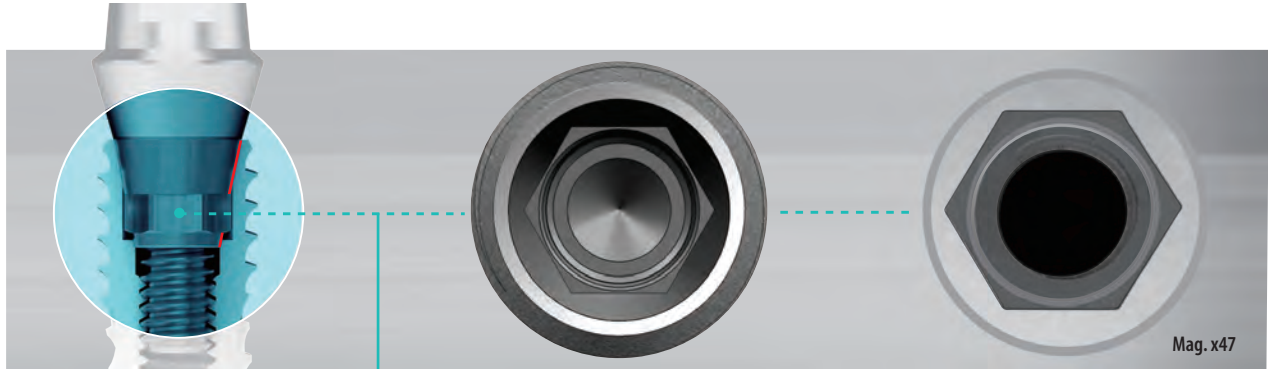

Tapered Hex Connection with Double Contacts

- > Allows for an ideal cold welding between the fixture and abutment.
- > Prevents micro-sinking of the abutment.
- > Minimizes micromovement and distribute stress against loading.

Wide and Deep Upper Threads

- > Prevent the compressive necrosis of the cortical bone.
- > Minimize the need for countersink drills.
- > Increase the mechanical strength by reinforcing the thickness.

Double Tapered Threads

- > Ensure initial stability even in areas with poor bone quality or alveolar socket.
- > Allow the fixture inserted more than half its length into the drilled hole to be placed in only 2 to 4 turns.
- > Achieve higher primary stability with wedge action, even with an additional half turn.

2 Spiral Round Cutting Edges

- > Maximizes self-tapping efficiency with sharp edges.
- > Ideal cutting-edge pocket design accommodates bone chips effectively.

Platform Neck

- > Enables stable engraftment of the periosteum at the interface between bone and implant.
- > Prevents inflammation around the implant.
- > The platform switching effect created by the three reduces stress on crestal bone, minimizing crestal bone loss.

Open Threads

- > Allow the fixture to be placed deeper without additional drilling.

Wide & Deep Body Thread

- > Deep and wide threads (0.9 pitch) increase the functional surface area at the bone-implant interface, enhancing primary stability in low-density bone or high occlusal load areas.

2 Flat Cutting Edge

- > Minimizes pressure on the gingival bone and improves self-tapping ability.

Flat Apex Thread

- > Provides initial fixation at the lower drill end.
- > Suitable for immediate placement in extraction sockets.
- > Facilitates favorable stress distribution to surrounding bone.



- > 2 Spiral Round Cutting Edges
- > 2 Flat Cutting Edge

Trapezoid Buttress thread

- > A unique design by Cowellmedi combining a basic trapezoid shape with a reverse buttress structure, ensuring optimal primary fixation in any bone quality from D1 to D4. Minimizes bone compression from compressive force and provides excellent stress distribution.

Advantageous design for all clinical cases such as immediate implant placement and loading, implant placement & immediate loading, implant depth adjustment, maxillary sinus, and etc.

Fixture type	Submerged (Sub.)	Submerged Short (Sub.)	Submerged Narrow (Sub-N.)	Internal (Int.)	External (Ext.)
Fixture Design	<p>INNO INNO X INNO V</p>				
Connection	<p>SUB. HEXAGON SYSTEM</p>		<p>SUB-N. HEXAGON SYSTEM</p>	<p>INT. OCTAGON SYSTEM</p>	<p>EXT. HEXAGON SYSTEM</p>

Simpler, Speedier, and Safer Surgical Kits

Providing dedicated kits for different types of fixtures.



All in One Drill: Minimal drilling frequency with Initial and Final Drill

Chair time for implantation is shortened because the fixture can be implanted with just three times of drilling for general bone quality (Fixture Ø3.5 to 4.5).



Abutment Prosthetic Protocol

> For digital procedure, refer to the COWELL Digital Products (Refer to the page 166 to 187).

1. Fixture Level Impression - Prosthesis Fabrication

* Two Piece Screw Retained Abutment

Submerged & Submerged Short : Temporary | Easy Temporary

External : Temporary

* Two Piece Screw-Cement Retained / Cement Retained Abutment

Submerged & Submerged Short : Cemented | Angulated | Beauty-up | Milling | Meta G UCLA | Plastic UCLA
Hybrid S | Hybrid L | Hybrid A | Ti-Block

Submerged Narrow : Cemented | Angulated | Temporary | Meta G UCLA | Hybrid S | Hybrid L | Hybrid A

Internal : Cemented | Angulated | Meta G UCLA | Hybrid S | Hybrid L

External : Cemented | Angulated | Temporary | Meta G UCLA | Plastic Sleeve

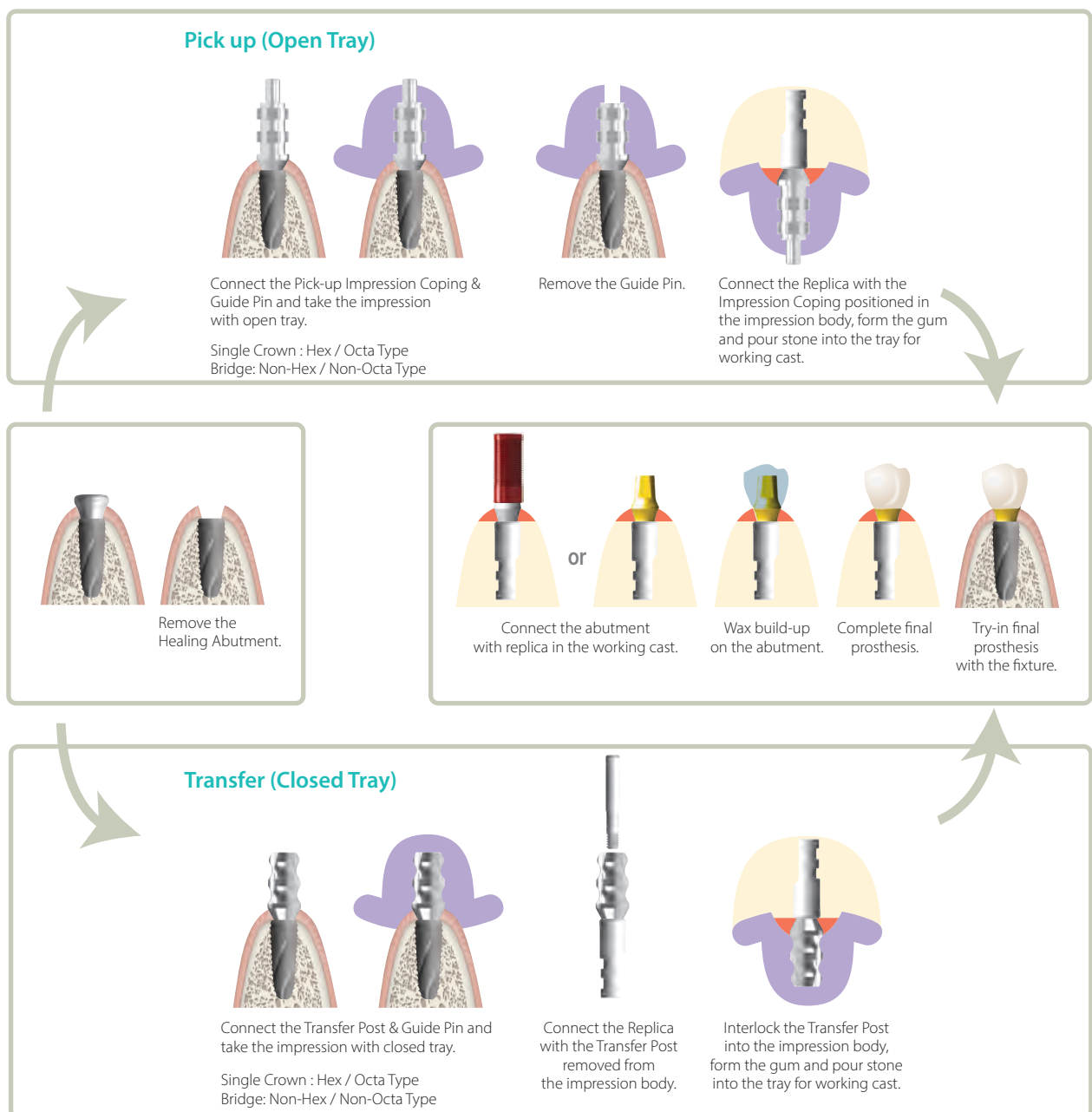

2. Abutment Level Impression - Prosthesis Fabrication

* Two / One Piece Screw Retained Abutment

Submerged & Submerged Short : Multi S | Multi A | Lock
 Submerged Narrow : Multi S | Multi A

* One Piece Cemented Retained Abutment

Submerged & Submerged Short : Absolute | Straight (Direct)
 Submerged Narrow : Straight
 Internal : Solid | Shoulder
 External : Shoulder

* Two / One Piece Attachment Retained Abutment

Submerged & Submerged Short : Sonator S | Sonator A | Ball
 Internal : Sonator S | Ball
 External : Ball

Indirect Impression Technique (No Abutment Modification Applied)

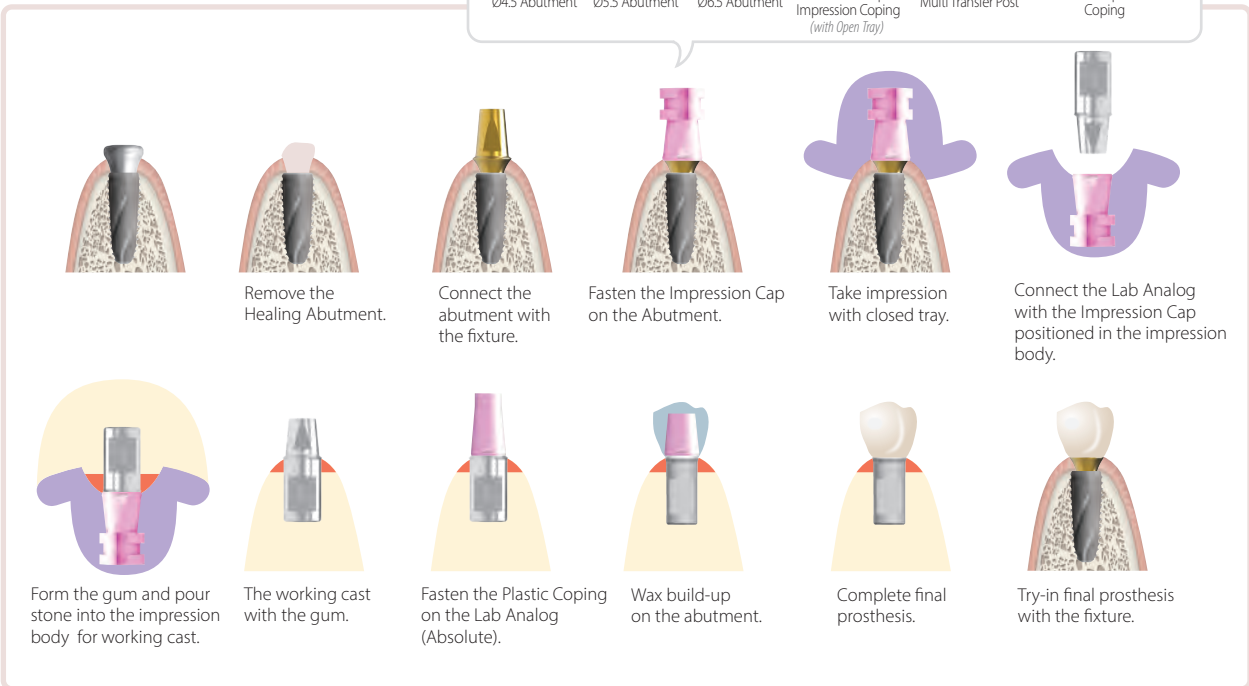



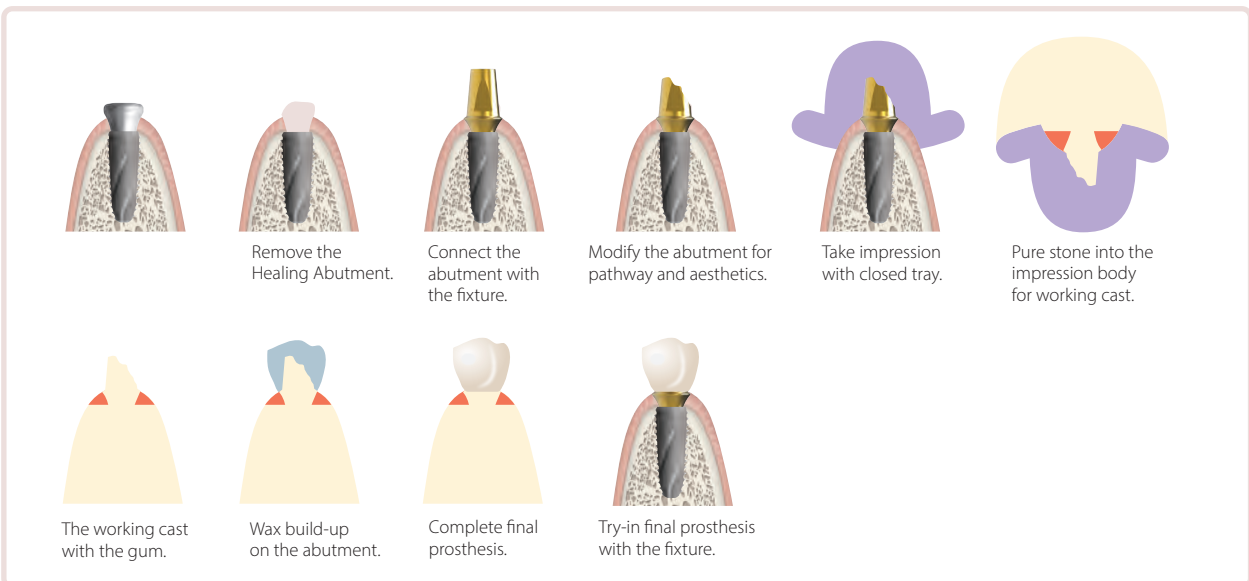













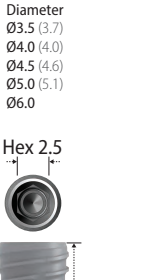

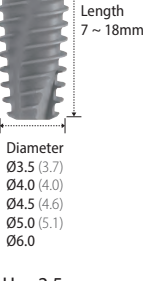

Direct Impression Technique (Abutment Modification Applied)

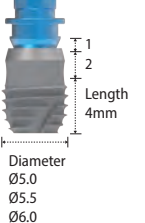

INNO SUBMERGED IMPLANT (Sub.)

System Flow

Fixture	Abutment							
 <p>Hex 2.5 Length 7 ~ 18mm</p>	Prosthetic Procedure I	 Cemented Abutment	 Angulated Abutment	 Beauty-up Abutment	 Milling Abutment	 Temporary Abutment	 Meta GUCLA Abutment	 Plastic UCLA Abutment
 <p>Hex 2.5 Diameter Ø3.5 (3.7) Ø4.0 (4.0) Ø4.5 (4.6) Ø5.0 (5.1) Ø6.0 Length 7 ~ 18mm</p>	Prosthetic Procedure II	 Multi S Abutment		 Multi A Abutment	 Multi Titanium Cylinder			
 <p>Hex 2.5 Diameter Ø3.5 (3.7) Ø4.0 (4.0) Ø4.5 (4.6) Ø5.0 (5.1) Ø6.0 Length 7 ~ 18mm</p>	Prosthetic Procedure III	 Absolute Abutment						
 <p>Hex 2.5 Diameter Ø3.5 (3.7) Ø4.0 (4.0) Ø4.5 (4.6) Ø5.0 (5.1) Ø6.0 Length 7 ~ 18mm</p>	Prosthetic Procedure IV	 Straight Abutment						
 <p>Hex 2.5 Diameter Ø3.5 (3.7) Ø4.0 (4.0) Ø4.5 (4.6) Ø5.0 (5.1) Ø6.0</p>	Prosthetic Procedure V	 Sonator S Abutment		 Sonator A Abutment				
 <p>Hex 2.5 Length 4mm Diameter Ø5.0 Ø5.5 Ø6.0</p>	Prosthetic Procedure VI	 Ball Abutment						

Impression

Fixture Level Impression

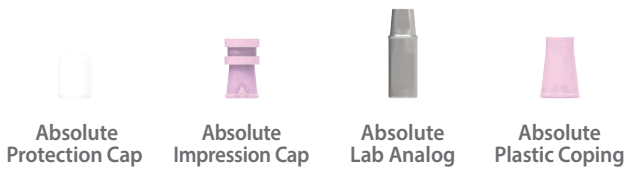
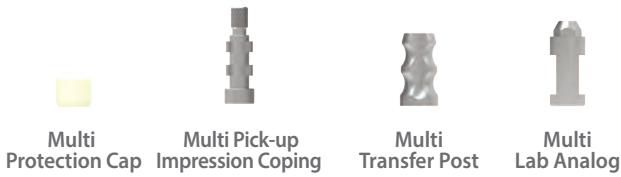

Abutment Level Impression

Direct Impression



INNO Submerged Implant



Submerged Fixture
Surface Treatment: **SLA-SH**

- > Interchangeable with hexagonal morse tapered fixture
- > Internal hex connection (Taper 11°/ Hex 2.5)

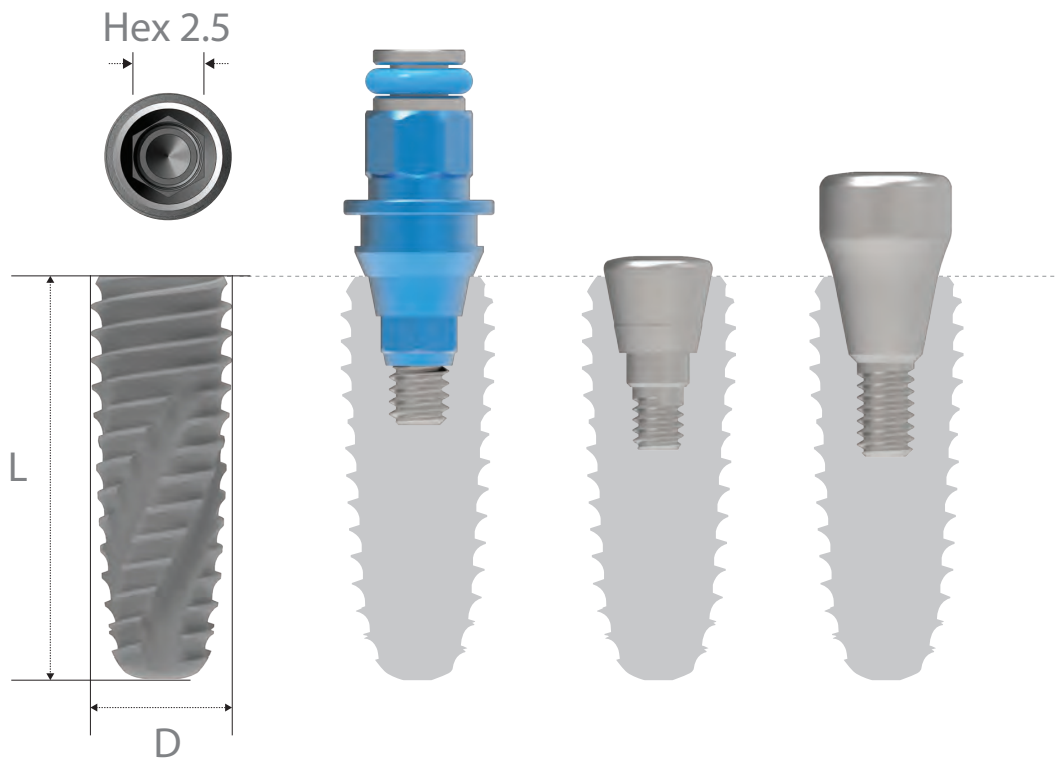

INNO Fixture Code

S	T	40	10	S	M	*Ex.)
Type Submerged	body Taper	Diameter Ø 4.0	Length 10 mm	Surface Treatment SLA	Mount No-Mount	SLA No-Mount
						ST4010SM

S	T	40	10	S		*Ex.)
Type Submerged	body Taper	Diameter Ø 4.0	Length 10 mm	Surface Treatment SLA	Mount Pre-Mount	SLA Pre-Mount
						ST4010S

No-Mount > Packing unit: 1 Fixture + 1 Cover Screw.

Diameter (Actual Size) **Ø3.5 (Ø3.7)**
Length

7	-
8	ST3508SM
10	ST3510SM
12	ST3512SM
14	ST3514SM

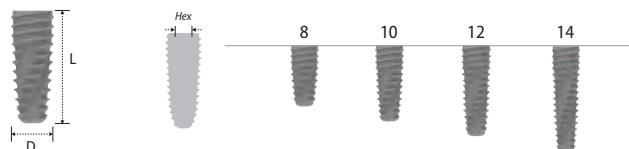

Diameter (Actual Size) **Ø4.0 (Ø4.2)**
Length

7	ST4007SM
8	ST4008SM
10	ST4010SM
12	ST4012SM
14	ST4014SM
16	ST4016SM
18	ST4018SM

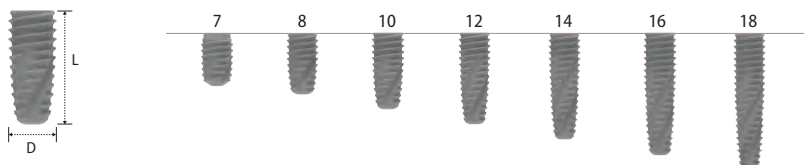

Diameter (Actual Size) **Ø4.5 (Ø4.6)**
Length

7	ST4507SM
8	ST4508SM
10	ST4510SM
12	ST4512SM
14	ST4514SM
16	ST4516SM
18	ST4518SM

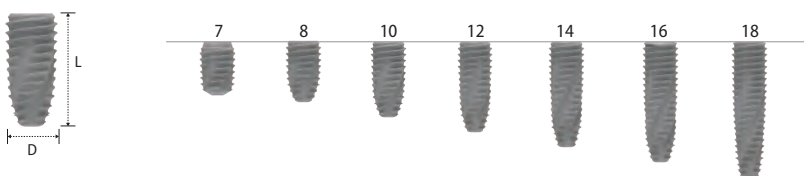

Diameter (Actual Size) **Ø5.0 (Ø5.1)**
Length

7	ST5007SM
8	ST5008SM
10	ST5010SM
12	ST5012SM
14	ST5014SM

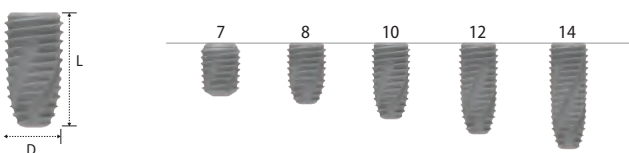

Diameter (Actual Size) **Ø6.0**
Length

7	ST6007SM
8 (7.5)	ST6008SM
10 (9.5)	ST6010SM
12 (11.5)	ST6012SM
14	-

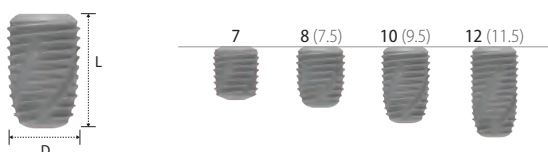

Pre-Mount > Packing unit: 1 Fixture + 1 Cover Screw + 1 Mount.

Diameter (Actual Size) **Ø3.5 (Ø3.7)**

Length

7	-
8	ST3508S
10	ST3510S
12	ST3512S
14	ST3514S

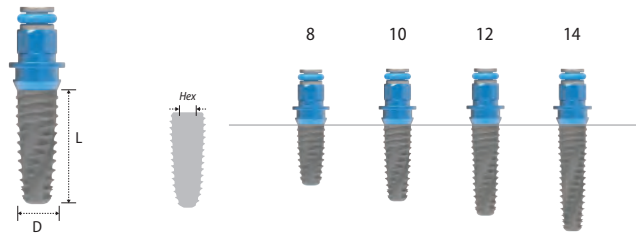

Diameter (Actual Size) **Ø4.0 (Ø4.2)**

Length

7	ST4007S
8	ST4008S
10	ST4010S
12	ST4012S
14	ST4014S
16	ST4016S
18	ST4018S

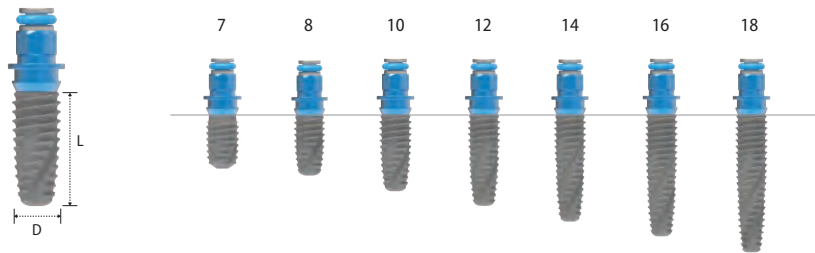

Diameter (Actual Size) **Ø4.5 (Ø4.6)**

Length

7	ST4507S
8	ST4508S
10	ST4510S
12	ST4512S
14	ST4514S
16	ST4516S
18	ST4518S

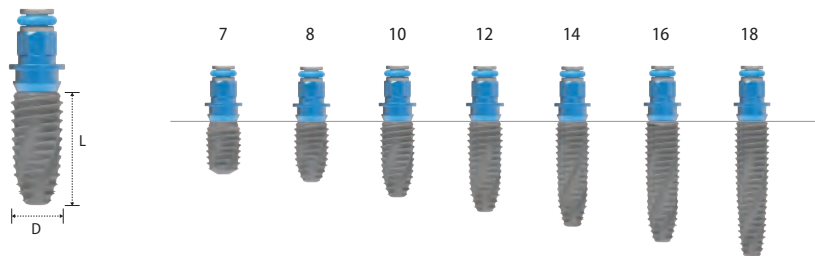

Diameter (Actual Size) **Ø5.0 (Ø5.1)**

Length

7	ST5007S
8	ST5008S
10	ST5010S
12	ST5012S
14	ST5014S

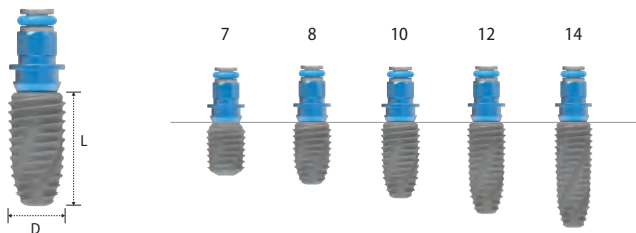

Diameter (Actual Size) **Ø6.0**

Length

7	ST6007S
8 (7.5)	ST6008S
10 (9.5)	ST6010S
12 (11.5)	ST6012S
14	-

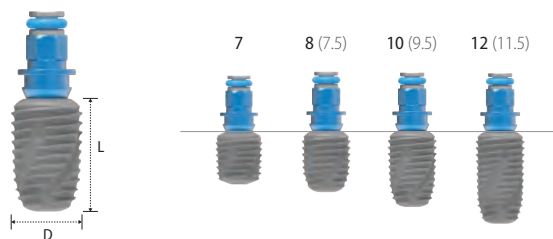

INNO X Implant



Submerged Fixture
Surface Treatment: **SLA-SH**

- > Interchangeable with hexagonal morse tapered fixture
- > Internal hex connection (Taper 11°/ Hex 2.5)
- > 2 spiral round cutting edge & 2 Flat cutting edge

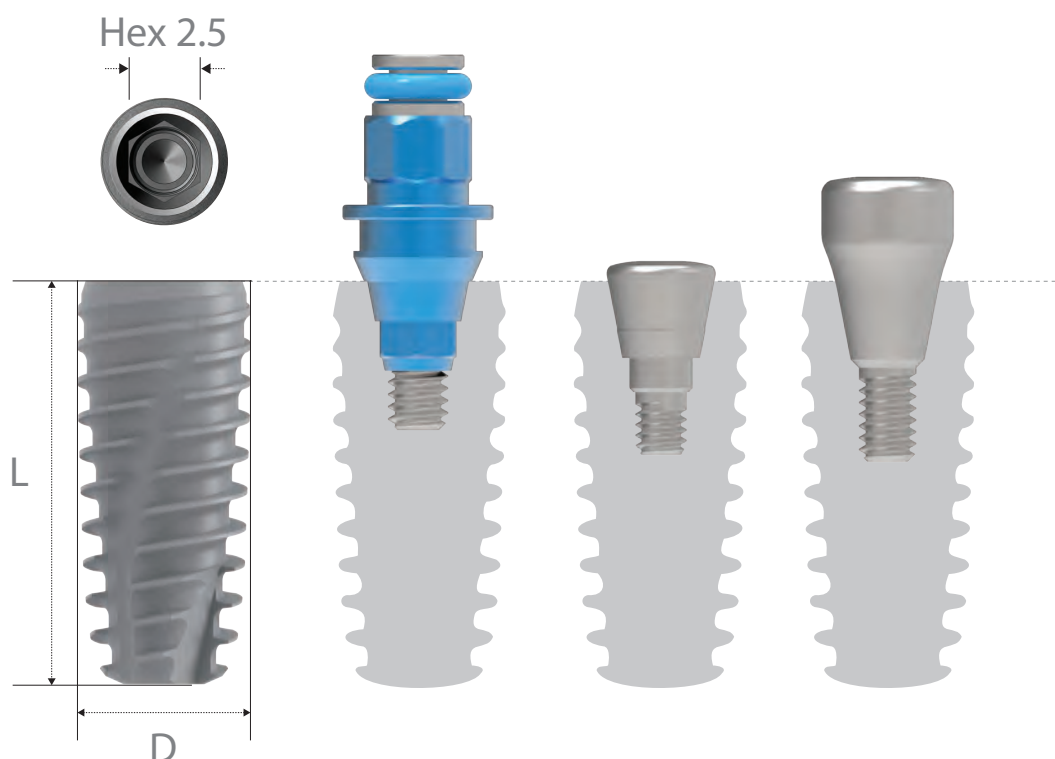

INNO Fixture Code

2	S	T	40	10	S	M	*Ex.)
Type	Type	body	Diameter	Length	Surface Treatment	Mount	SLA No-Mount
X	Submerged	Taper	Ø 4.0	10mm	SLA	No-Mount	2ST4010SM

2	S	T	40	10	S		*Ex.)
Type	Type	body	Diameter	Length	Surface Treatment	Mount	SLA Pre-Mount
X	Submerged	Taper	Ø 4.0	10mm	SLA	Pre-Mount	2ST4010S

No-Mount > Packing unit: 1 Fixture + 1 Cover Screw.

Diameter (Actual Size) **Ø3.5 (Ø3.7)**
 Length

7	-
8	2ST3508SM
10	2ST3510SM
12	2ST3512SM
14	2ST3514SM

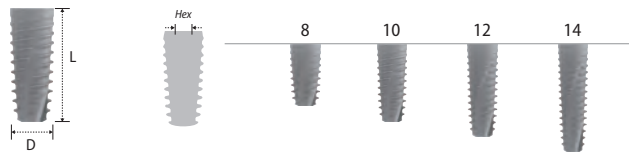

Diameter (Actual Size) **Ø4.0 (Ø4.2)**
 Length

7	2ST4007SM
8	2ST4008SM
10	2ST4010SM
12	2ST4012SM
14	2ST4014SM
16	2ST4016SM
18	2ST4018SM

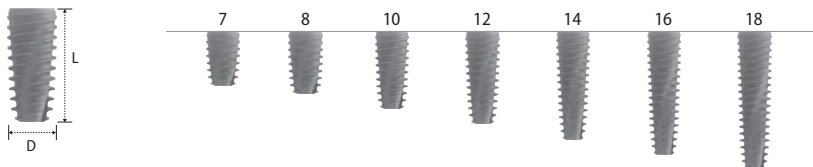

Diameter (Actual Size) **Ø4.5 (Ø4.6)**
 Length

7	2ST4507SM
8	2ST4508SM
10	2ST4510SM
12	2ST4512SM
14	2ST4514SM
16	2ST4516SM
18	2ST4518SM

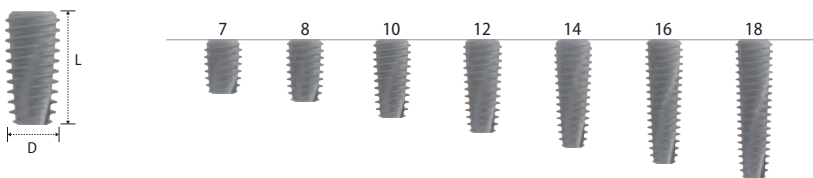

Diameter (Actual Size) **Ø5.0 (Ø5.1)**
 Length

7	2ST5007SM
8	2ST5008SM
10	2ST5010SM
12	2ST5012SM
14	2ST5014SM

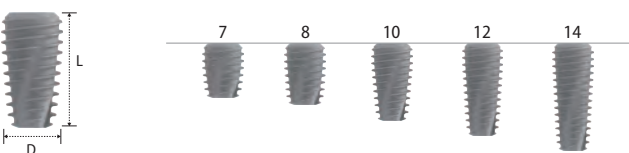

Diameter **Ø6.0**
 Length (Actual Size)

7	2ST6007SM
8 (7.5)	2ST6008SM
10 (9.5)	2ST6010SM
12 (11.5)	2ST6012SM
14	-

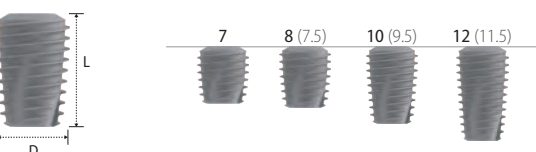

Pre-Mount > Packing unit: 1 Fixture + 1 Cover Screw + 1 Mount.

Diameter (Actual Size) **Ø3.5 (Ø3.7)**

Length

7	-
8	2ST3508S
10	2ST3510S
12	2ST3512S
14	2ST3514S

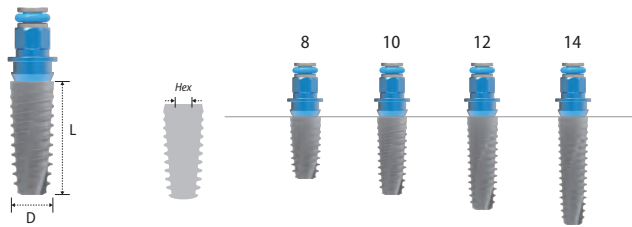

Diameter (Actual Size) **Ø4.0 (Ø4.2)**

Length

7	2ST4007S
8	2ST4008S
10	2ST4010S
12	2ST4012S
14	2ST4014S
16	2ST4016S
18	2ST4018S

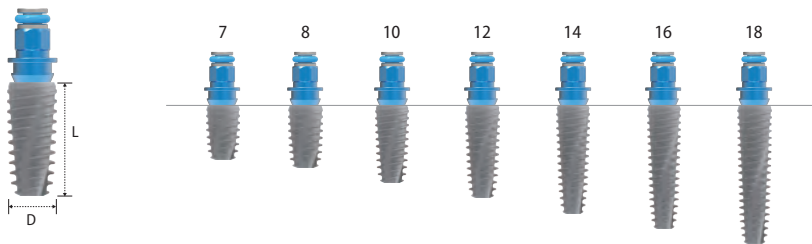

Diameter (Actual Size) **Ø4.5 (Ø4.6)**

Length

7	2ST4507S
8	2ST4508S
10	2ST4510S
12	2ST4512S
14	2ST4514S
16	2ST4516S
18	2ST4518S

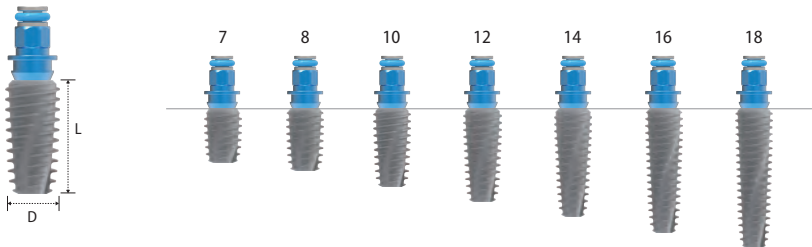

Diameter (Actual Size) **Ø5.0 (Ø5.1)**

Length

7	2ST5007S
8	2ST5008S
10	2ST5010S
12	2ST5012S
14	2ST5014S

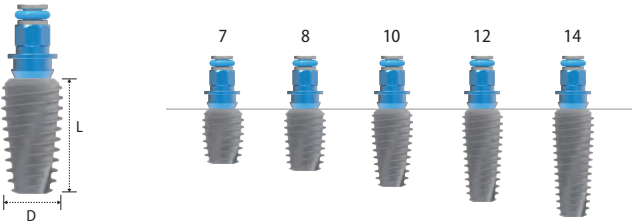

Diameter (Actual Size) **Ø6.0**

Length

7	2ST6007S
8 (7.5)	2ST6008S
10 (9.5)	2ST6010S
12 (11.5)	2ST6012S
14	-

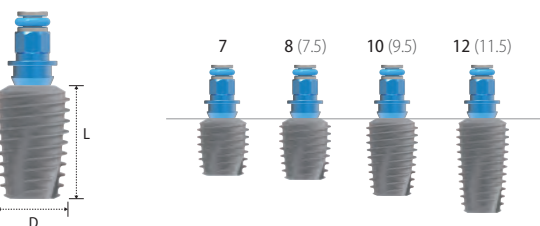

INNO V Implant



Submerged Fixture
Surface Treatment: **SLA-SH**

- > Interchangeable with hexagonal morse tapered fixture
- > Internal hex connection (Taper 11°/ Hex 2.5)
- > 2 spiral round cutting edge & 2 Flat cutting edge

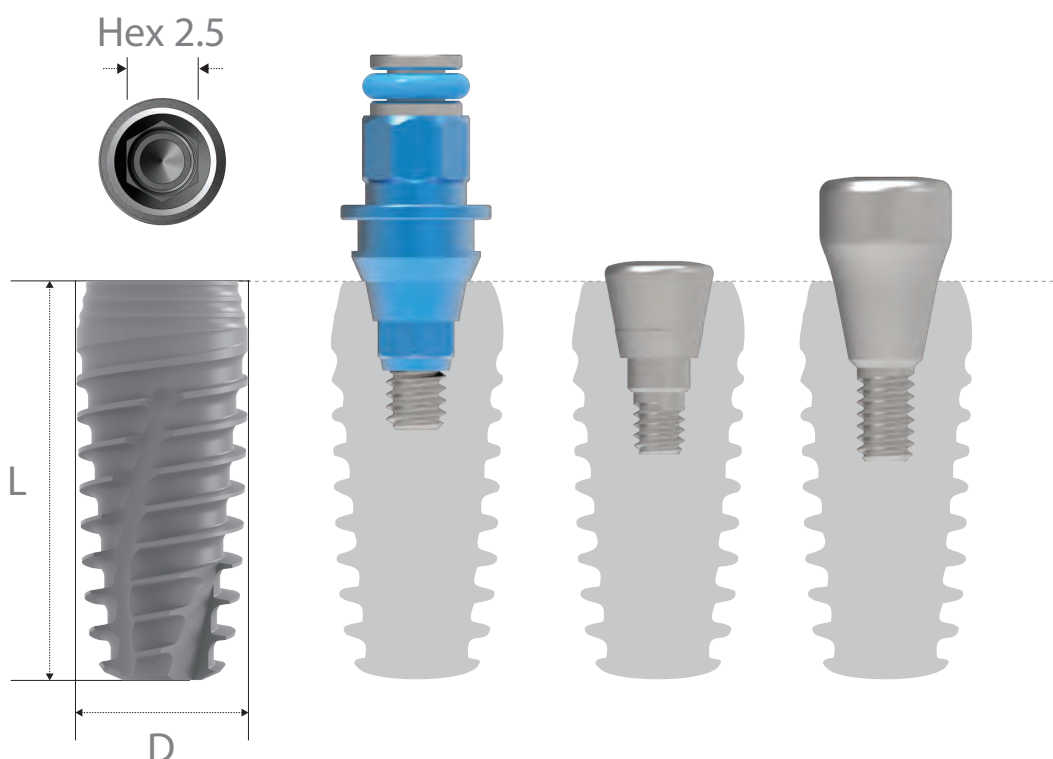

INNO Fixture Code

I2	S	T	40	10	S	M	*Ex.)
Type	Type	body	Diameter	Length	Surface Treatment	Mount	SLA No-Mount
V	Submerged	Taper	Ø4.0	10mm	SLA	No-Mount	I2ST4010SM

I2	S	T	40	10	S		*Ex.)
Type	Type	body	Diameter	Length	Surface Treatment	Mount	SLA Pre-Mount
V	Submerged	Taper	Ø4.0	10mm	SLA	Pre-Mount	I2ST4010S

No-Mount > Packing unit: 1 Fixture + 1 Cover Screw.

Diameter (Actual Size) **Ø3.5 (Ø3.7)**
 Length

7	-
8	I2ST3508SM
10	I2ST3510SM
12	I2ST3512SM
14	I2ST3514SM

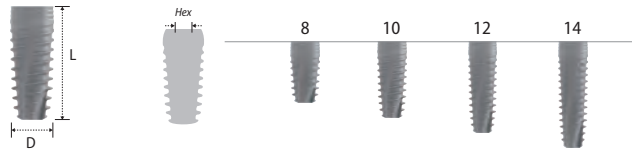

Diameter (Actual Size) **Ø4.0 (Ø4.2)**
 Length

7	I2ST4007SM
8	I2ST4008SM
10	I2ST4010SM
12	I2ST4012SM
14	I2ST4014SM
16	I2ST4016SM
18	I2ST4018SM

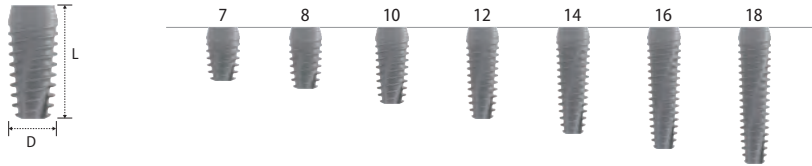

Diameter (Actual Size) **Ø4.5 (Ø4.6)**
 Length

7	I2ST4507SM
8	I2ST4508SM
10	I2ST4510SM
12	I2ST4512SM
14	I2ST4514SM
16	I2ST4516SM
18	I2ST4518SM

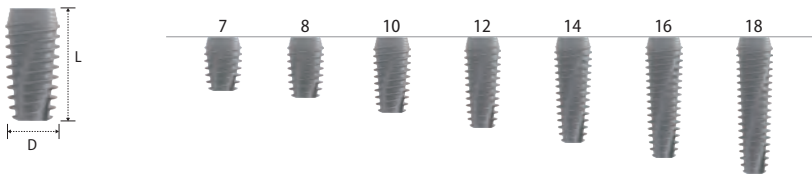

Diameter (Actual Size) **Ø5.0 (Ø5.1)**
 Length

7	I2ST5007SM
8	I2ST5008SM
10	I2ST5010SM
12	I2ST5012SM
14	I2ST5014SM

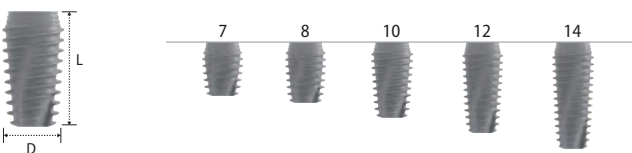

Diameter **Ø6.0**
 Length (Actual Size)

7	I2ST6007SM
8 (7.5)	I2ST6008SM
10 (9.5)	I2ST6010SM
12 (11.5)	I2ST6012SM
14	-

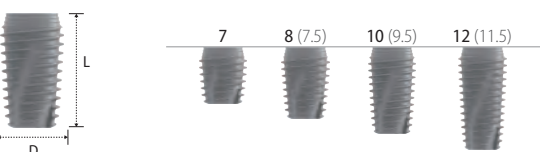

Pre-Mount > Packing unit: 1 Fixture + 1 Cover Screw + 1 Mount.

Diameter (Actual Size) **Ø3.5 (Ø3.7)**

Length

7	-
8	I2ST3508S
10	I2ST3510S
12	I2ST3512S
14	I2ST3514S

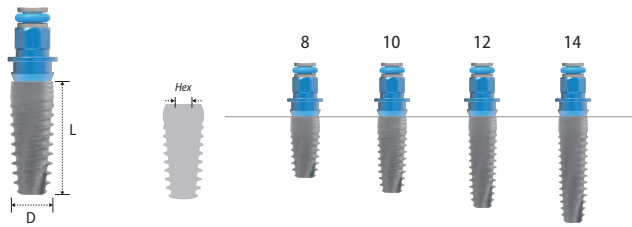

Diameter (Actual Size) **Ø4.0 (Ø4.2)**

Length

7	I2ST4007S
8	I2ST4008S
10	I2ST4010S
12	I2ST4012S
14	I2ST4014S
16	I2ST4016S
18	I2ST4018S

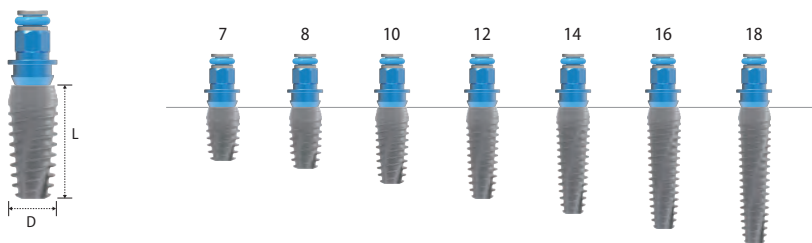

Diameter (Actual Size) **Ø4.5 (Ø4.6)**

Length

7	I2ST4507S
8	I2ST4508S
10	I2ST4510S
12	I2ST4512S
14	I2ST4514S
16	I2ST4516S
18	I2ST4518S

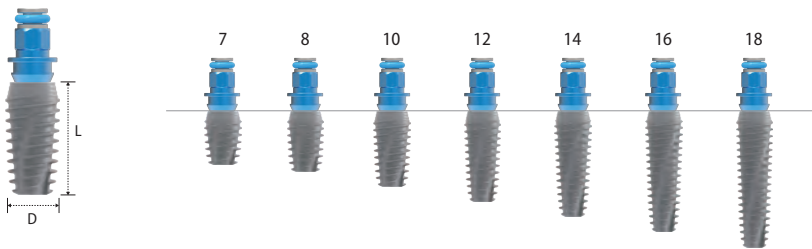

Diameter (Actual Size) **Ø5.0 (Ø5.1)**

Length

7	I2ST5007S
8	I2ST5008S
10	I2ST5010S
12	I2ST5012S
14	I2ST5014S

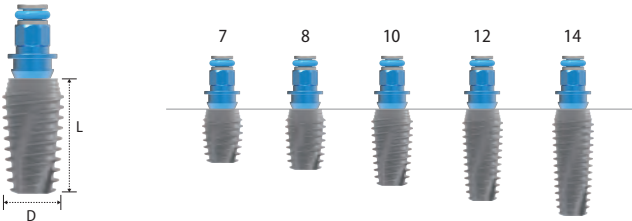

Diameter **Ø6.0**

Length (Actual Size)

7	I2ST6007S
8 (7.5)	I2ST6008S
10 (9.5)	I2ST6010S
12 (11.5)	I2ST6012S
14	-

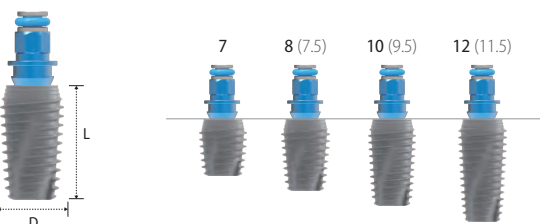

INNO Submerged Short Implant



Submerged Short Fixture
Surface Treatment: **SLA-SH**

- > Interchangeable with Hexagonal Morse Tapered Fixture.
- > Internal hex connection (Taper 11° Hex 2.5).

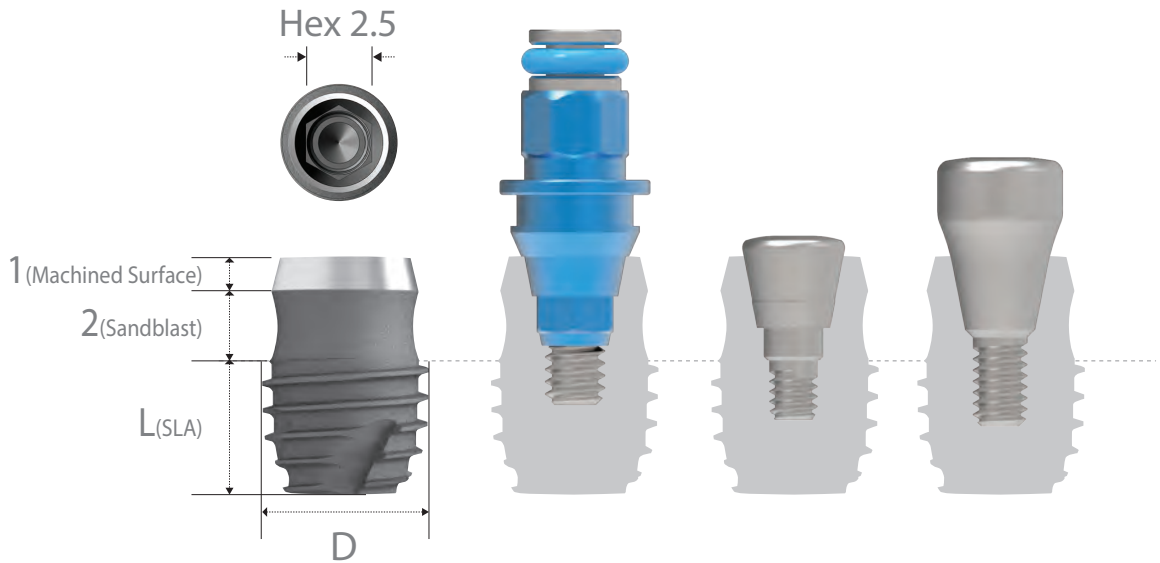

Pre-Mount > Packing Unit: 1 Fixture + 1 Cover Screw + 1 Mount.

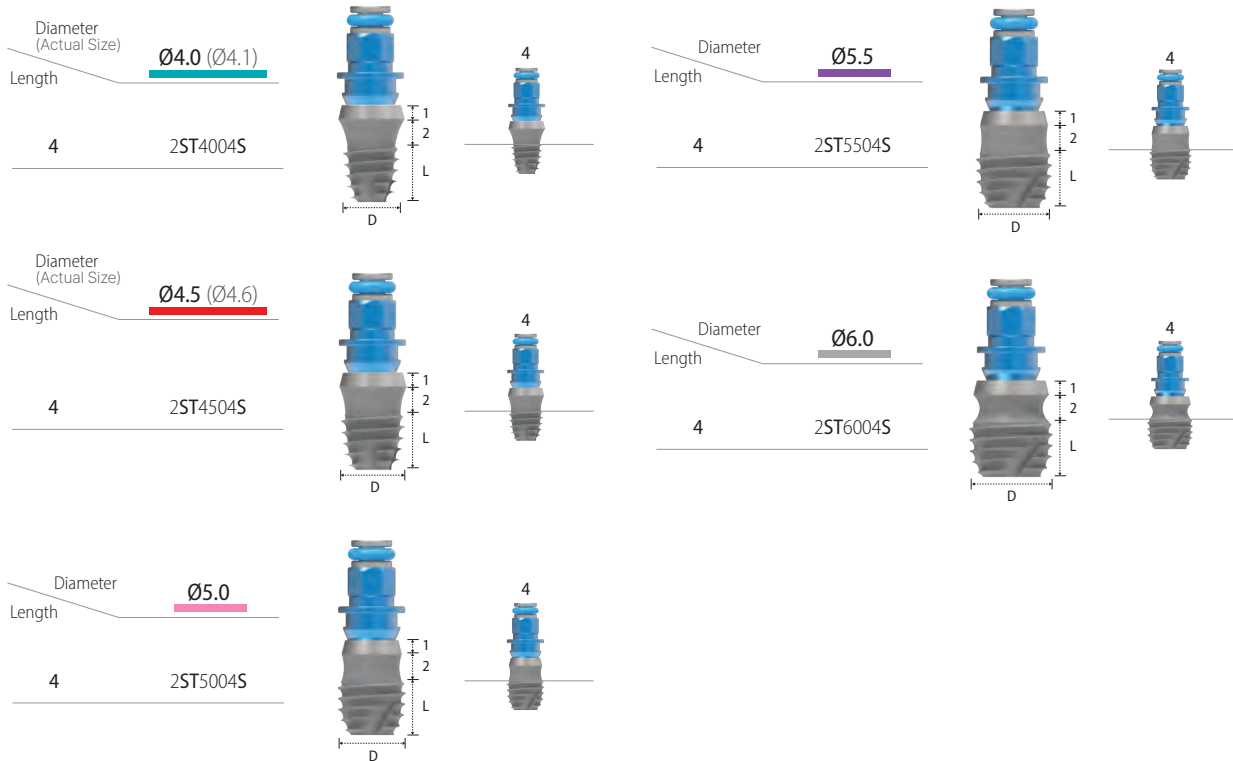

Fixture Mount

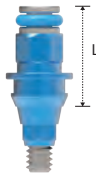

Length	5.4
	2SMHR001

- > Packing unit: 1 Mount + 1 Mount Screw.
- > Tightened with the Hex Driver.
- > Tightening torque force: 10N.cm.

Cover Screw



Diameter / Length	Ø3.35	Ø3.75	Ø4.15
3	2SCS000		
4.2		* 2SCS001	
5.2			* 2SCS002

- > Packing unit: 1 Cover Screw. *Extra Product
- > To seal the conical interface of the fixture.
- > The longer Cover Screw for the deeply inserted fixture.
- > Tightened with the Hex Driver.
- > Tightening torque force: 10N.cm.

Healing Abutment

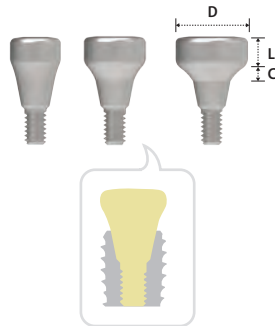

Diameter	Ø4.0		Ø4.5		Ø5.0		Ø5.5	
Length / Cuff	1	2	1	2	1	2	1	2
1	2HS4011		2HS4511		2HS5011		2HS5511	
2		2HS4022		2HS4522		2HS5022		2HS5522
3		2HS4032		2HS4532		2HS5032		2HS5532
4		2HS4042		2HS4542		2HS5042		2HS5542
5		2HS4052		2HS4552		2HS5052		2HS5552
6		2HS4062		2HS4562		2HS5062		2HS5562
7		2HS4072		2HS4572		2HS5072		2HS5572

Diameter	Ø6.0		Ø6.5		Ø7.0		Ø7.5/Ø8.5/Ø9.5	
Length / Cuff	1	2	1	2	1	2		
1	2HS6011		2HS6511		2HS7011			
2		2HS6022		2HS6522		2HS7022		
3		2HS6032		2HS6532		2HS7032		
4		2HS6042		2HS6542		2HS7042	Cuff 3	2HS7532
5		2HS6052		2HS6552		2HS7052		2HS8532
6		2HS6062		2HS6562		2HS7062		2HS9532
7		2HS6072		2HS6572		2HS7072		

- > Packing unit: 1 Healing Abutment.
- > For remodeling gingival contour during soft tissue healing.
- > Select the abutment according to gingival height and abutment type.
- > Tightened with the Hex Driver.
- > Tightening torque force: 10N.cm.

Volume-up Healing Abutment

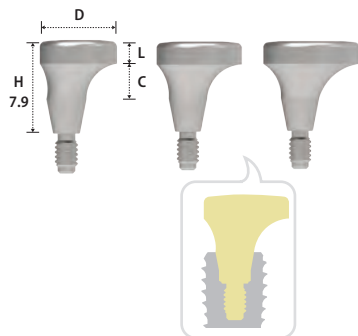

Diameter	Ø6.5	Ø7.5	Ø8.5
Length / Cuff	2	2	2
3	VUHN6532	VUHN7532	VUHN8532

- > Packing unit: 1 Volume-up Healing Abutment (Inbuilt Abutment Screw).
- > Used for an implant procedure to form the gingival tissue and alveolar bone in the form of natural teeth and gums by prevention or minimizing the food penetration.
- > Extremely effective when used with the COWELL BMP.
- > Recommended to use with the Volume-up Guide System.
- > Select the abutment according to gingival height and abutment type.
- > Tightened with the Hex Driver.
- > Tightening torque force: 10N.cm.



Prosthetic Procedure I

Components Selection Guide for Cemented and UCLA Abutment

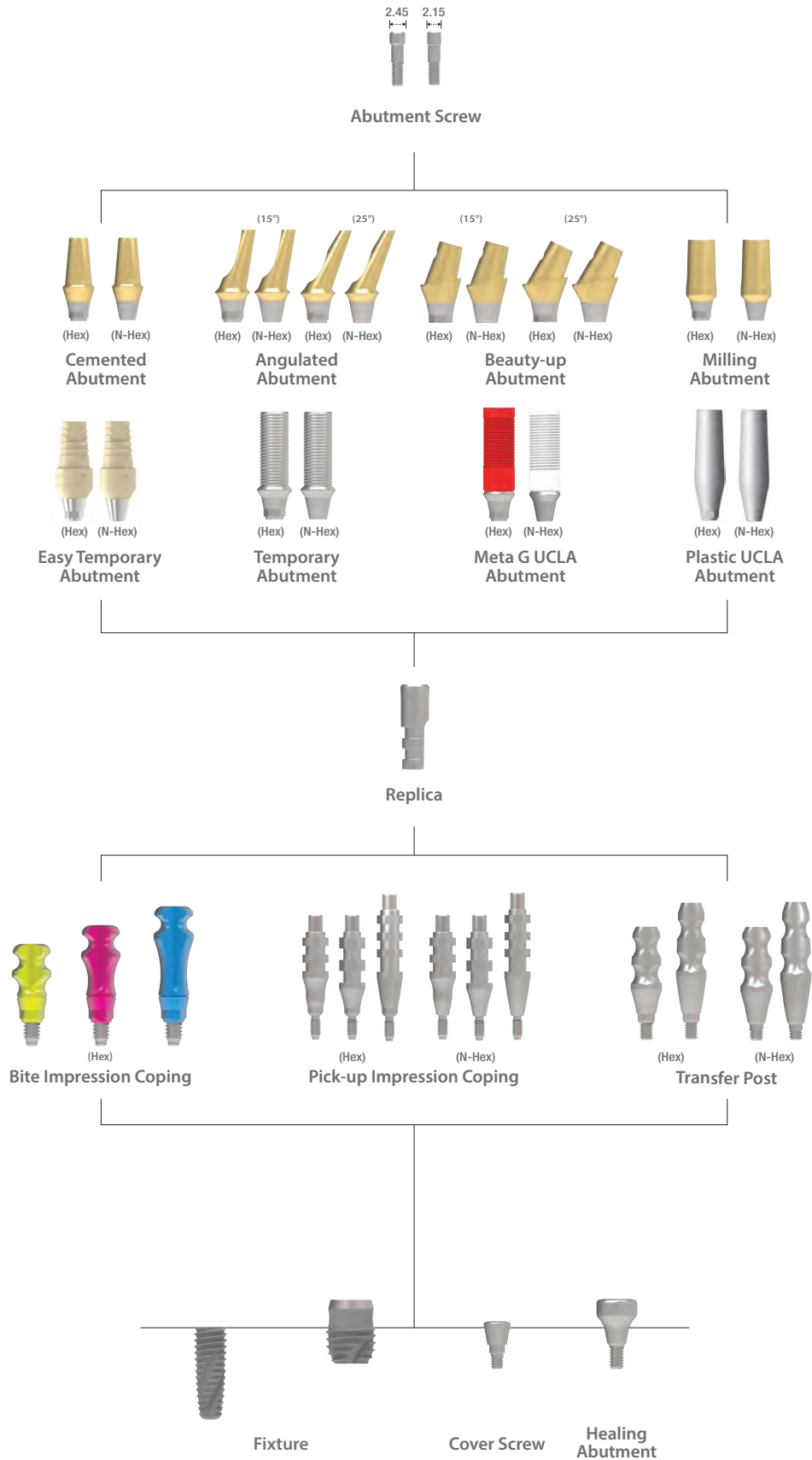

Cemented Abutment

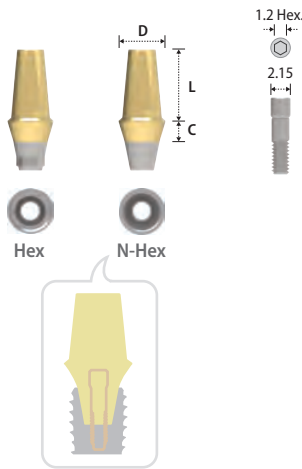

Type	Hex														
	Ø4.5			Ø5.0			Ø5.5			Ø6.0			Ø6.5		
Diameter															
Length Cuff	4	5.5	7	4	5.5	7	4	5.5	7	4	5.5	7	4	5.5	7
1	2SCH 4514	2SCH 4515	2SCH 4517	2SCH 5014	2SCH 5015	2SCH 5017	2SCH 5514	2SCH 5515	2SCH 5517	2SCH 6014	2SCH 6015	2SCH 6017	2SCH 6514	2SCH 6515	2SCH 6517
2	2SCH 4524	2SCH 4525	2SCH 4527	2SCH 5024	2SCH 5025	2SCH 5027	2SCH 5524	2SCH 5525	2SCH 5527	2SCH 6024	2SCH 6025	2SCH 6027	2SCH 6524	2SCH 6525	2SCH 6527
3	2SCH 4534	2SCH 4535	2SCH 4537	2SCH 5034	2SCH 5035	2SCH 5037	2SCH 5534	2SCH 5535	2SCH 5537	2SCH 6034	2SCH 6035	2SCH 6037	2SCH 6534	2SCH 6535	2SCH 6537
4	2SCH 4544	2SCH 4545	2SCH 4547	2SCH 5044	2SCH 5045	2SCH 5047	2SCH 5544	2SCH 5545	2SCH 5547	2SCH 6044	2SCH 6045	2SCH 6047	2SCH 6544	2SCH 6545	2SCH 6547
5	2SCH 4554	2SCH 4555	2SCH 4557	2SCH 5054	2SCH 5055	2SCH 5057	2SCH 5554	2SCH 5555	2SCH 5557	2SCH 6054	2SCH 6055	2SCH 6057	2SCH 6554	2SCH 6555	2SCH 6557

Type	N-Hex														
	Ø4.5			Ø5.0			Ø5.5			Ø6.0			Ø6.5		
Diameter															
Length Cuff	4	5.5	7	4	5.5	7	4	5.5	7	4	5.5	7	4	5.5	7
1	2SCN 4514	2SCN 4515	2SCN 4517	2SCN 5014	2SCN 5015	2SCN 5017	2SCN 5514	2SCN 5515	2SCN 5517	2SCN 6014	2SCN 6015	2SCN 6017	2SCN 6514	2SCN 6515	2SCN 6517
2	2SCN 4524	2SCN 4525	2SCN 4527	2SCN 5024	2SCN 5025	2SCN 5027	2SCN 5524	2SCN 5525	2SCN 5527	2SCN 6024	2SCN 6025	2SCN 6027	2SCN 6524	2SCN 6525	2SCN 6527
3	2SCN 4534	2SCN 4535	2SCN 4537	2SCN 5034	2SCN 5035	2SCN 5037	2SCN 5534	2SCN 5535	2SCN 5537	2SCN 6034	2SCN 6035	2SCN 6037	2SCN 6534	2SCN 6535	2SCN 6537
4	2SCN 4544	2SCN 4545	2SCN 4547	2SCN 5044	2SCN 5045	2SCN 5047	2SCN 5544	2SCN 5545	2SCN 5547	2SCN 6044	2SCN 6045	2SCN 6047	2SCN 6544	2SCN 6545	2SCN 6547
5	2SCN 4554	2SCN 4555	2SCN 4557	2SCN 5054	2SCN 5055	2SCN 5057	2SCN 5554	2SCN 5555	2SCN 5557	2SCN 6054	2SCN 6055	2SCN 6057	2SCN 6554	2SCN 6555	2SCN 6557

- > Packing unit: 1 Cemented Abutment + 1 Abutment Screw.
- > For Screw-Cement or Cement Retained Prosthesis.
- > Cutting surface for anti-rotation of the prosthesis.
- > Gold color for more translucent restoration.
- > Library available for EXOCAD®, 3Shape® & Others.
- > Connected with the Abutment Screw (2SSHR200).
- > Tightened with the Hex Driver and Torque Wrench.
- > Tightening torque force: 30N.cm.
- > Use the Scanbody for 3D Work.
- > Fixture level impression.

Angulated Abutment

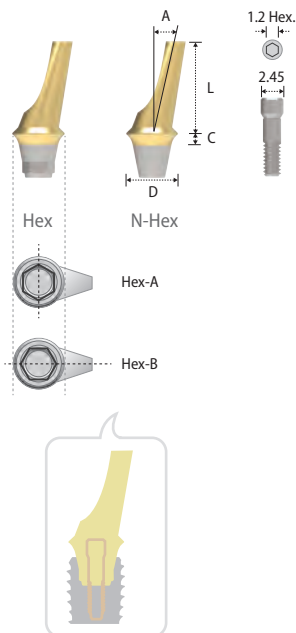

Type	Hex-A				Hex-B			
	Ø4.5(15°)	Ø4.5(25°)	Ø5.5(15°)	Ø5.5(25°)	Ø4.5(15°)	Ø4.5(25°)	Ø5.5(15°)	Ø5.5(25°)
Diameter(Angle)								
Length Cuff	8	8	8	8	8	8	8	8
1	2SAH45151	2SAH45251	2SAH55151	2SAH55251	2SAH45151B	2SAH45251B	2SAH55151B	2SAH55251B
2	2SAH45152	2SAH45252	2SAH55152	2SAH55252	2SAH45152B	2SAH45252B	2SAH55152B	2SAH55252B
3	2SAH45153	2SAH45253	2SAH55153	2SAH55253	2SAH45153B	2SAH45253B	2SAH55153B	2SAH55253B
4	2SAH45154	2SAH45254	2SAH55154	2SAH55254	2SAH45154B	2SAH45254B	2SAH55154B	2SAH55254B

Type	N-Hex			
	Ø4.5(15°)	Ø4.5(25°)	Ø5.5(15°)	Ø5.5(25°)
Diameter(Angle)				
Length Cuff	8	8	8	8
1	2SAN45151	2SAN45251	2SAN55151	2SAN55251
2	2SAN45152	2SAN45252	2SAN55152	2SAN55252
3	2SAN45153	2SAN45253	2SAN55153	2SAN55253
4	2SAN45154	2SAN45254	2SAN55154	2SAN55254

- > Packing unit: 1 Angulated Abutment + 1 Abutment Screw.
- > For Screw-Cement or Cement Retained Prosthesis.
- > Solution for the anterior esthetic zone.
- > Connected with the Abutment Screw (2SSHR100).
- > Gold color for more translucent restoration.
- > Select Hex-A or Hex-B according to the case.
- > Tightened with the Hex Driver and Torque Wrench.
- > Tightening torque force: 30N.cm.
- > Fixture level impression.

Beauty-up Abutment

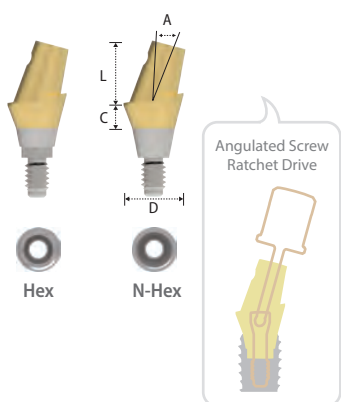

Type	Hex	N-Hex	Hex	N-Hex
Diameter(Angle)	Ø3.8 (15°)	Ø3.8 (15°)	Ø3.8 (25°)	Ø3.8 (25°)
Length	5	5	5	5
Cuff	2	2SBH381525	2SBN381525	2SBH382525
				2SBN382525

- > Packing unit: 1 Beauty-up Abutment (Inbuilt Abutment Screw).
- > For Screw-Cement Retained Prosthesis with angulated screw channel.
- > The ultimate solution for the anterior esthetic zone.
- > The gingival line of the Beauty-up Abutment allows more esthetic prosthesis.
- > Oval design allows lower incisal application (Mesiodistal diameter: 3.8mm).
- > Tightened with the Torx A Ratchet Driver and Torque Wrench.
- > Tightening torque force: 30N.cm.
- > Library available for EXOCAD®, 3Shape® & Others.
- > Use the Scanbody for 3D Work.
- > Fixture level impression.

* Torx A Ratchet Driver



Height	Type	Ratchet
24(Short)		KRBUD15
29(Long)		KRBUD20

- > Stable to internal slip or fracture due to wide contact area of the Torx A Driver and the dedicated Stargrip Abutment Screw.
- > Tightening torque force: 30N.cm (50N.cm Max.).

Milling Abutment

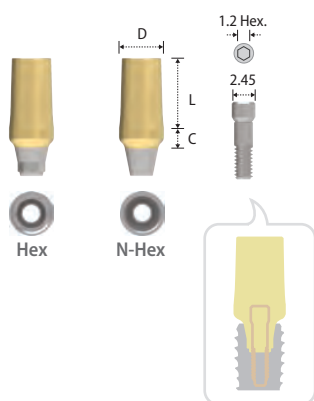

Type	Hex			N-Hex		
Diameter	Ø4.5	Ø5.5	Ø6.5	Ø4.5	Ø5.5	Ø6.5
Length	7	7	7	7	7	7
Cuff	2	2SMH4527	2SMH5527	2SMH6527	2SMN4527	2SMN5527
						2SMN6527
	4	2SMH4547	2SMH5547	2SMH6547	2SMN4547	2SMN5547
						2SMN6547

- > Packing unit: 1 Milling Abutment + 1 Abutment Screw.
- > For Screw-Cement or Cement Retained Prosthesis.
- > Block abutment for customized contouring.
- > Gold color for more translucent restoration.
- > Connected with the Abutment Screw (2SSHR100).
- > Tightened with the Hex Driver and Torque Wrench.
- > Tightening torque force: 30N.cm.
- > Fixture level impression.

Easy Temporary Abutment

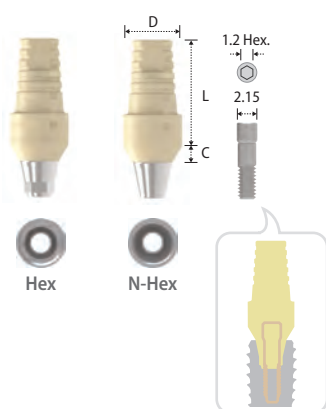

Type	Hex		N-Hex	
Diameter	Ø4.5	Ø5.5	Ø4.5	Ø5.5
Length	10	10	10	10
Cuff	2	2STHA45C	2STHA55C	2STNA45C
				2STNA55C

- > Packing unit: 1 Easy Temporary Abutment + 1 Abutment Screw.
- > For Screw Retained Prosthesis.
- > For simpler and speedier chair-side process.
- > Venerable polymer material.
- > Temporary restoration for the anterior esthetic zone.
- > Titanium core for strength.
- > Connected with the Abutment Screw (2SSHR200).
- > Tightened with the Hex Driver and Torque Wrench.
- > Tightening torque force: 20N.cm.
- > Fixture level impression.

Temporary Abutment

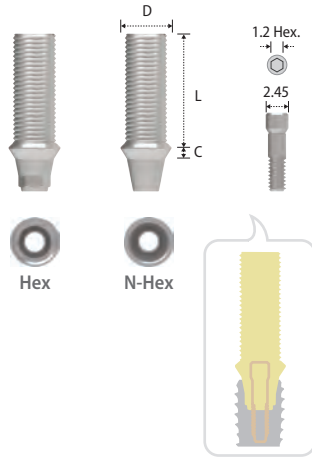

Type	Hex	N-Hex
Diameter	Ø4.5	Ø4.5
Length Cuff	10	10
1	2STHA45	2STNA45

- > Packing unit: 1 Temporary Abutment + 1 Abutment Screw.
- > For Screw-Cement Retained Prosthesis.
- > For provisional restoration.
- > Connected with the Abutment Screw (2SSHR100).
- > Tightened with the Hex Driver and Torque Wrench.
- > Tightening torque force: 20N.cm.
- > Fixture level impression.

Meta G UCLA Abutment

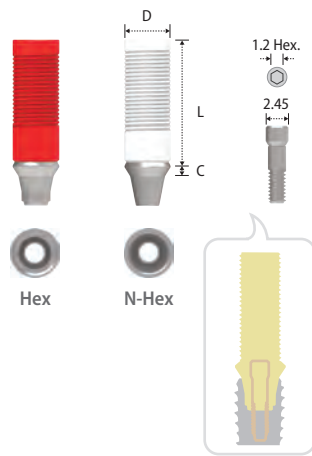

Type	Hex	N-Hex
Diameter	Ø4.5	Ø4.5
Length Cuff	12	12
1	2SGH45N	2SGN45N
2	2SGH452N	2SGN452N
3	2SGH453N	2SGN453N

- > Packing unit: 1 Meta G UCLA Abutment + 1 Abutment Screw.
- > For Screw-Cement or Screw Retained Prosthesis.
- > Modification to the angulated abutment, customized abutment, and telescopic abutment.
- > CCM alloy core for precise connection.
- > Cast with non-precious metal or gold alloy.
- > Connected with the Abutment Screw (2SSHR100).
- > Tightened with the Hex Driver and Torque Wrench.
- > Tightening torque force: 30N.cm.
- > Fixture level impression.

Plastic UCLA Abutment

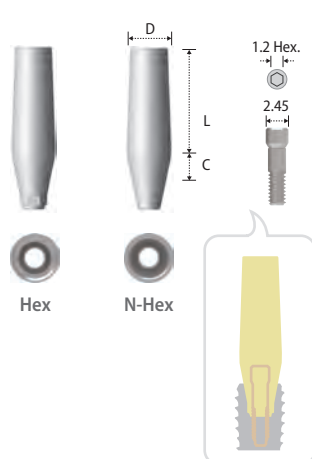

Type	Hex		N-Hex	
Diameter	Ø4.5	Ø5.5	Ø4.5	Ø5.5
Length Cuff	11	11	11	11
3	2SPHR001	2SPHW001	2SPNR001	2SPNW001

- > Packing unit: 1 Plastic UCLA Abutment + 1 Abutment Screw.
- > Same purpose of use as the Meta G UCLA Abutment but the low accuracy of connection during lab procedure.
- > PMMA material.
- > Connected with the Abutment Screw (2SSHR200).
- > Tightened with the Hex Driver and Torque Wrench.
- > Tightening torque force: Finger light force during wax pattern fabrication, 30N.cm after casting.
- > Fixture level impression.

Abutment Screw

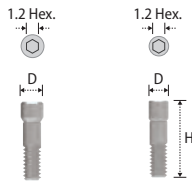

Diameter	Ø2.45	Ø2.15
Height	2SSHR100	2SSHR200

- > Packing unit: 1 Abutment Screw.
- > 2SSHR100: Angulated, Milling, Temporary, Meta G UCLA, and Plastic UCLA Abutment.
- > 2SSHR200: Cemented and Easy Temporary Abutment.
- > Tightened with the Hex Driver and Torque Wrench.

Replica



Diameter	Ø4.0
Height	2SRHR001

- > Packing unit: 1 Replica.
- > Mimicking of the conical interface of the fixture.
- > Analog of fixture for the working cast.

Bite Impression Coping



Type	Hex(Short)	Hex(Long)	Hex(X-Long)
Diameter	Ø4.5	Ø4.5	Ø4.5
Length / Cuff	2	4	6
	4.0	2SBIC45S	2SBIC45L
			2SBIC45X

- > Packing unit: 1 Bite Impression Coping (Inbuilt Guide Pin).
- > Designed to simultaneously take bite and impression.
- > For closed tray impression (Bite Impression).
- > Tightened with the Hex Driver and Torque Wrench.
- > Tightening torque force: 12~15N.cm.
- > Fixture level impression.

Pick-up Impression Coping

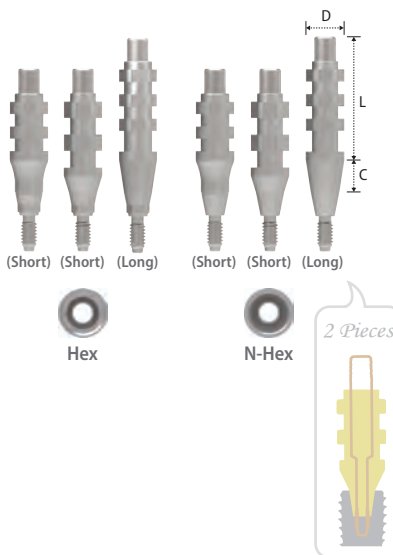

Type	Hex			N-Hex		
Diameter / Length / Cuff	Ø4.5	Ø5.5	Ø6.5	Ø4.5	Ø5.5	Ø6.5
12 (Short) / 4	2SIH454S	2SIH554S	2SIH654S	2SIN454S	2SIN554S	2SIN654S
14 (Short) / 2	2SIH45S	2SIH55S	2SIH65S	2SIN45S	2SIN55S	2SIN65S
16 (Long) / 4	2SIH45L	2SIH55L	2SIH65L	2SIN45L	2SIN55L	2SIN65L

- > Packing unit: 1 Pick-up Impression Coping + 1 Guide Pin.
- > For open tray impression.
- > Connected with the Guide Pin (2SISR001SS / 2SISR001SL).
- > Tightened with the Hex Driver and Torque Wrench.
- > Tightening torque force: 12~15N.cm.
- > Fixture level impression.

Transfer Post

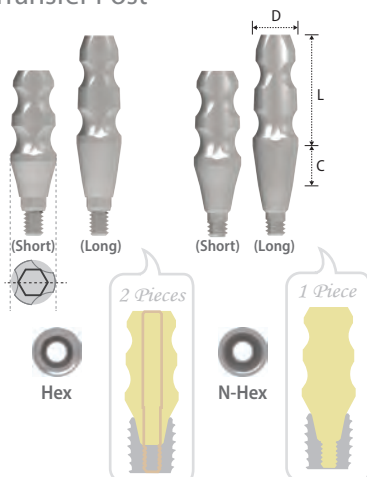

Type	Hex			N-Hex		
Diameter / Length / Cuff	Ø4.5	Ø5.5	Ø6.5	Ø4.5	Ø5.5	Ø6.5
9 (Short) / 2	2STH45S	2STH55S	2STH65S	2STN45S	2STN55S	2STN65S
11 (Long) / 4	2STH45L	2STH55L	2STH65L	2STN45L	2STN55L	2STN65L

- > Packing unit: Hex - 1 Transfer Post + 1 Guide Pin / N-Hex - 1 Transfer Post (Solid Type).
- > For closed tray impression.
- > Connected with the Guide Pin (2STH001SS / 2STH001SL).
- > Tightened with the Hex Driver and Torque Wrench.
- > Tightening torque force: 12~15N.cm.
- > Fixture level impression.

Prosthetic Procedure II

Component Selection Guide for Multi S&A Abutment

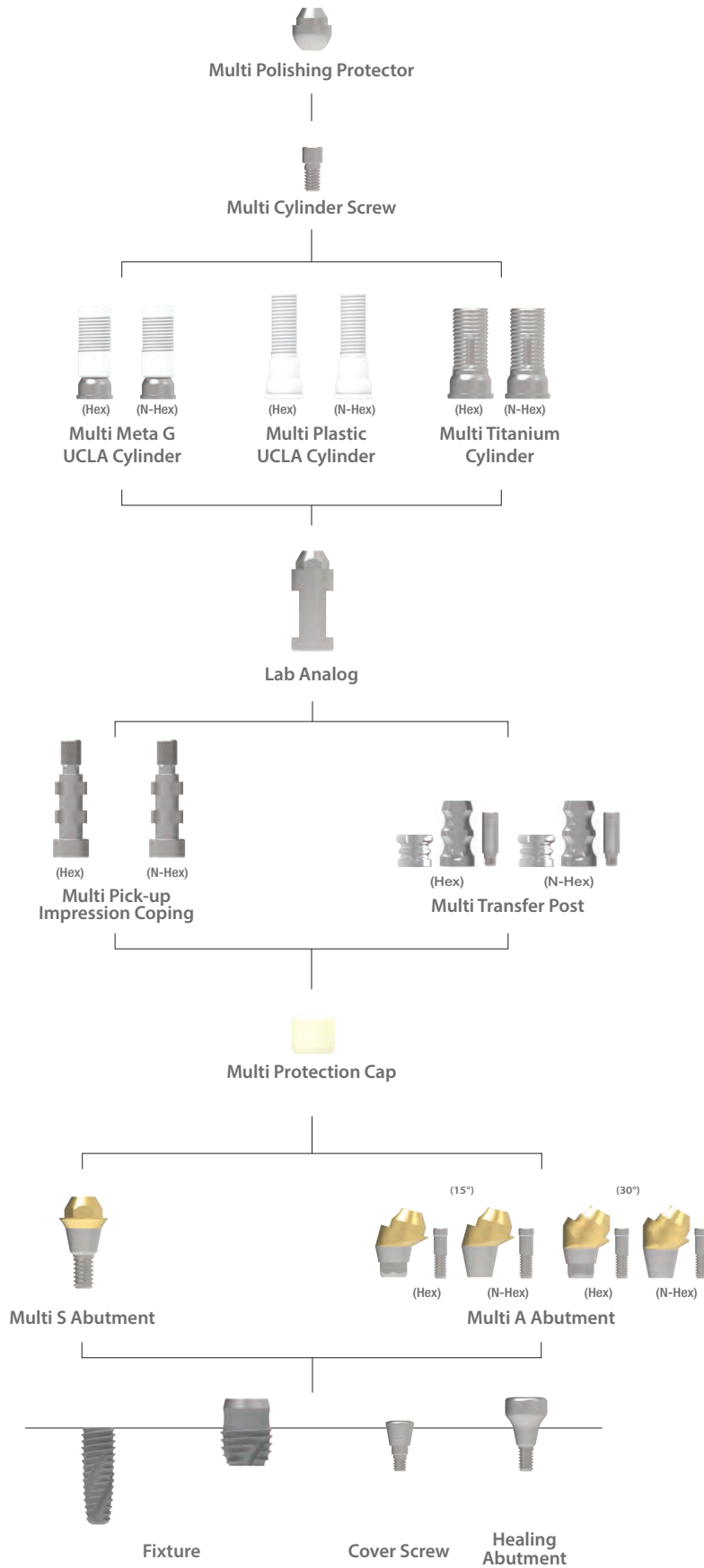

Multi S Abutment

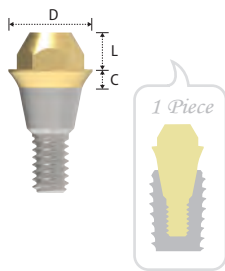

Diameter	Ø4.5	Ø5.5
Cuff / Length	2	2
1	2SMS451	2SMS551
2	2SMS452	2SMS552
3	2SMS453	2SMS553
4	2SMS454	2SMS554
5	2SMS455	2SMS555

- > Packing unit: 1 Multi S Abutment.
- > For Screw-Retained Prosthesis.
- > Titanium base for the cylinders.
- > Gold color for more translucent restoration.
- > Integrated with screw and abutment.
- > Library available for EXOCAD®, 3Shape® & Others.
- > Use the S Holder for a more stable position.
- > Tightened with the S Machine & S Ratchet Driver and Torque Wrench.
- > Tightening torque force: 30N.cm.
- > Abutment level impression.

Multi A Abutment

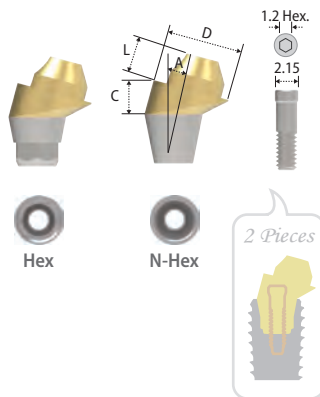

Type	Hex			
Diameter(Angle)	Ø4.5(15°)	Ø4.5(30°)	Ø5.5(15°)	Ø5.5(30°)
Cuff / Length	2	2	2	2
2	● 2SMAH45152			
3	★ 2SMAH45153	● 2SMAH45303	★ 2SMAH55153	★ 2SMAH55303
4	★ 2SMAH45154	★ 2SMAH45304	★ 2SMAH55154	★ 2SMAH55304
5			★ 2SMAH55155	★ 2SMAH55305

Type	N-Hex			
Diameter(Angle)	Ø4.5(15°)	Ø4.5(30°)	Ø5.5(15°)	Ø5.5(30°)
Cuff / Length	2	2	2	2
2	● 2SMAN45152			
3	★ 2SMAN45153	● 2SMAN45303	★ 2SMAN55153	★ 2SMAN55303
4	★ 2SMAN45154	★ 2SMAN45304	★ 2SMAN55154	★ 2SMAN55304
5			★ 2SMAN55155	★ 2SMAN55305

- > Packing unit: 1 Multi A Abutment + 1 Abutment Screw.
- > For Screw-Retained Prosthesis.
- > Titanium base for the cylinders.
- > Gold color for more translucent restoration.
- > Library available for EXOCAD®, 3Shape® & others.
- > Use the A Holder for a more stable position.
- > Connected with the Abutment Screw (2SSHR300: ★ / 2SSHR400: ●).
- > Tightened with the Hex Driver and Torque Wrench.
- > Tightening torque force: 30N.cm.
- > Use the Multi Scanbody for digital flow.
- > Abutment level impression.

Abutment Screw

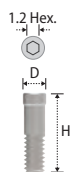

Height / Diameter	7.5	6.5
2.15	★ 2SSHR300	● 2SSHR400

- > Packing unit: 1 Abutment Screw.
- > To connect the Multi A Abutment.
- > Tightened with the Hex Driver and Torque Wrench.

Multi Protection Cap

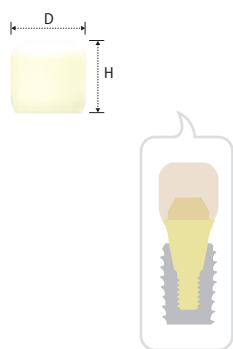

Multi S & A Abutment Diameter	Ø4.5	Ø5.5
Diameter Height	Ø5.2	Ø6.2
5	2SMPC45	2SMPC55

- > Packing unit: 1 Multi Protection Cap.
- > Protection from cheek and tongue for gingival healing period.
- > Gingival retraction for prosthodontic margin of the abutment.
- > Alternative usage for sub-structure of the temporary prosthesis.
- > Tightened with the Hex Driver.
- > Tightening torque force: 5~10N.cm.

Multi Pick-up Impression Coping

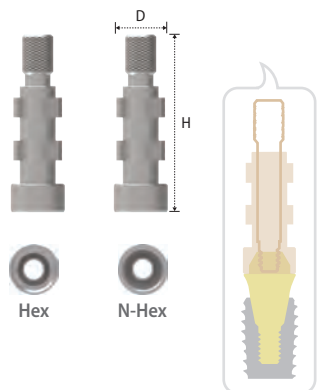

Type	Hex		N-Hex	
Multi S & A Abutment Diameter	Ø4.5	Ø5.5	Ø4.5	Ø5.5
Diameter Height	Ø4.65	Ø5.65	Ø4.65	Ø5.65
16	2SMIH45	2SMIH55	2SMIN45	2SMIN55

- > Packing unit: 1 Multi Pick-up Impression Coping + 1 Guide Pin.
- > For open tray impression.
- > Connected with the Guide Pin (2SMGP012).
- > Tightened with the Hex Driver and Torque Wrench.
- > Tightening torque force: 12~15N.cm.

Multi Transfer Post

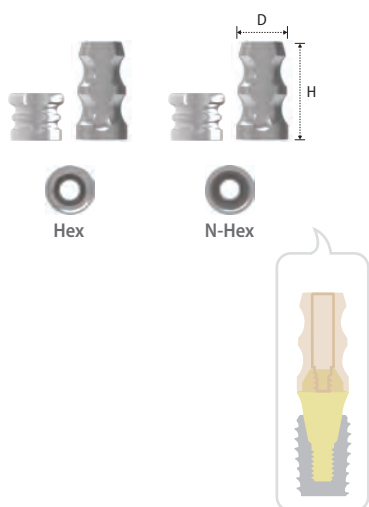

Type	Hex		N-Hex	
Multi S & A Abutment Diameter	Ø4.5	Ø5.5	Ø4.5	Ø5.5
Diameter Height	Ø4.5	Ø5.5	Ø4.5	Ø5.5
5	2SMTH455	2SMTH555	2SMTN455	2SMTN555
8.5	2SMTH45	2SMTH55	2SMTN45	2SMTN55

- > Packing unit: 1 Multi Transfer Post + 1 Guide Pin.
- > For closed tray impression.
- > Connected with the Guide Pin (2SMTHS100).
- > Tightened with the Hex Driver and Torque Wrench.
- > Tightening torque force: 12~15N.cm.

Multi Lab Analog



Multi S & A Abutment Diameter	Ø4.5	Ø5.5
Diameter Length	Ø4.5	Ø5.5
2	2SMA45	2SMA55

- > Packing unit: 1 Multi Lab Analog.
- > Replacement of abutment shape in working cast.
- > Choose by abutment size.

Multi Meta G UCLA Cylinder

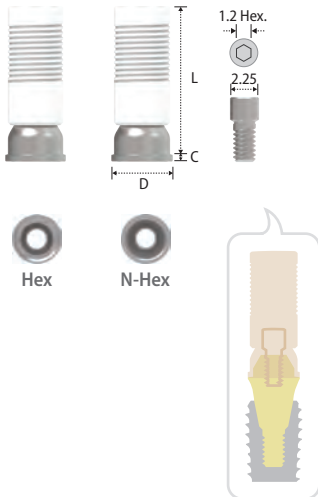

Type	Hex		N-Hex	
Multi S & A Abutment Diameter	Ø4.5	Ø5.5	Ø4.5	Ø5.5
Diameter	Ø4.5	Ø5.5	Ø4.5	Ø5.5
Length Cuff	10.9	10.9	10.9	10.9
0.5	2SCCH45	2SCCH55	2SCCN45	2SCCN55

- > Packing unit: 1 Multi Meta G UCLA Cylinder + 1 Multi Cylinder Screw.
- > For Screw, Cement, or Screw-Cement Retained Prosthesis.
- > Modification to various types of abutments.
- > CCM alloy core for precise connection.
- > Cast with non-precious metal or gold alloy.
- > Connected with the Multi Cylinder Screw (2SMCS100).
- > Tightened with the Hex Driver and Torque Wrench.
- > Tightening torque force: 20N.cm.

Multi Plastic UCLA Cylinder

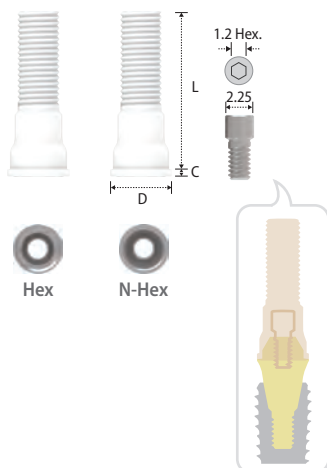

Type	Hex		N-Hex	
Multi S & A Abutment Diameter	Ø4.5	Ø5.5	Ø4.5	Ø5.5
Diameter	Ø4.5	Ø5.5	Ø4.5	Ø5.5
Length Cuff	11.5	11.5	11.5	11.5
0.5	2SMPH45	2SMPH55	2SMPN45	2SMPN55

- > Packing unit: 1 Multi Plastic UCLA Cylinder + 1 Multi Cylinder Screw.
- > For Screw, Cement or Screw-Cement Retained Prosthesis.
- > Same purpose of use as the Meta G UCLA Cylinder but the low accuracy of connection.
- > PMMA material.
- > Connected with the Multi Cylinder Screw (2SMCS100).
- > Tightened with the Hex Driver and Torque Wrench.
- > Tightening torque force: 20N.cm.

Multi Titanium Cylinder

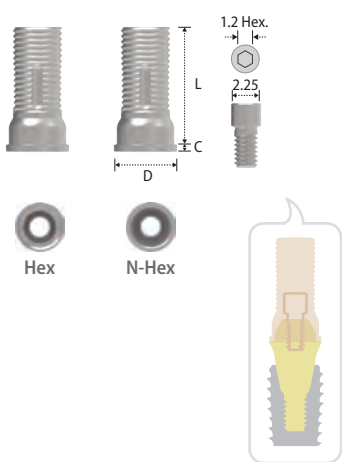

Type	Hex		N-Hex	
Multi S & A Abutment Diameter	Ø4.5	Ø5.5	Ø4.5	Ø5.5
Diameter	Ø4.5	Ø5.5	Ø4.5	Ø5.5
Length	8.5	8.5	8.5	8.5
Cuff	0.5	2STCH45	2STCH55	2STCN45
			2STCN55	

- > Packing unit: 1 Multi Titanium Cylinder + 1 Multi Cylinder Screw.
- > For Screw, Cement or Screw-Cement Retained Prosthesis.
- > Connected with the Multi Cylinder Screw (2SMCS100).
- > Tightened with the Hex Driver and Torque Wrench.
- > Tightening torque force: 20N.cm.

Multi Cylinder Screw

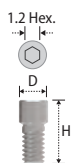

Diameter	Height
Ø2.25	5
	2SMCS100

- > Packing unit: 1 Multi Cylinder Screw.
- > Connected with the Meta G UCLA, Plastic UCLA, and Titanium Cylinder.
- > Tightened with the Hex Driver and Torque Wrench.
- > Tightening torque force: 20N.cm.

Multi Polishing Protector

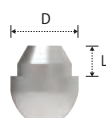

Type	Hex	
Multi S & A Abutment Diameter	Ø4.5	Ø5.5
Diameter	Ø4.5	Ø5.5
Length	2	2
	2SMPP45	2SMPP55

- > Packing unit: 1 Multi Polishing Protector.
- > To protect margin of the prosthesis while polishing procedure.

Multi Holder

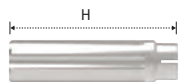

S Holder



Height	Type	Hand
20		KMHS01

- > Packing unit: 1 Multi S Holder.
- > To position the Multi S Abutment more stably.

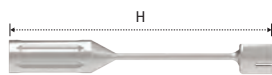

A Holder

Height	Type	Hand
32		KMHA01

- > Packing unit: 1 Multi A Holder.
- > To position the Multi A Abutment more stably.



- ① Connect the Multi A Holder with the Multi A Abutment with its Abutment Screw in it and match the direction of holes of the abutment and the holder.



- ② Hold the handle of the Multi A Holder and bend it according to the placement position in the oral cavity.



- ③ Connect the assembled body with the fixture.



- ④ Tighten the Multi Abutment with the Hex Driver and Torque Wrench.

Multi S Machine Driver

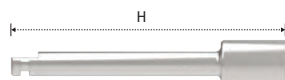

Height	Type	Machine
27.5		KMMSD21L

- > Packing unit: 1 Multi S Machine Driver.
- > To install and remove the Multi S Abutment by machine.

Multi S Ratchet Driver

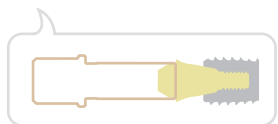
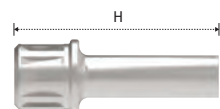

Height	Type	Ratchet
22		KRMSD15L

- > Packing unit: 1 Multi S Ratchet Driver.
- > To install and remove the Multi S Abutment with the Torque Wrench.

Prosthetic Procedure III

Component Selection Guide for Lock Abutment

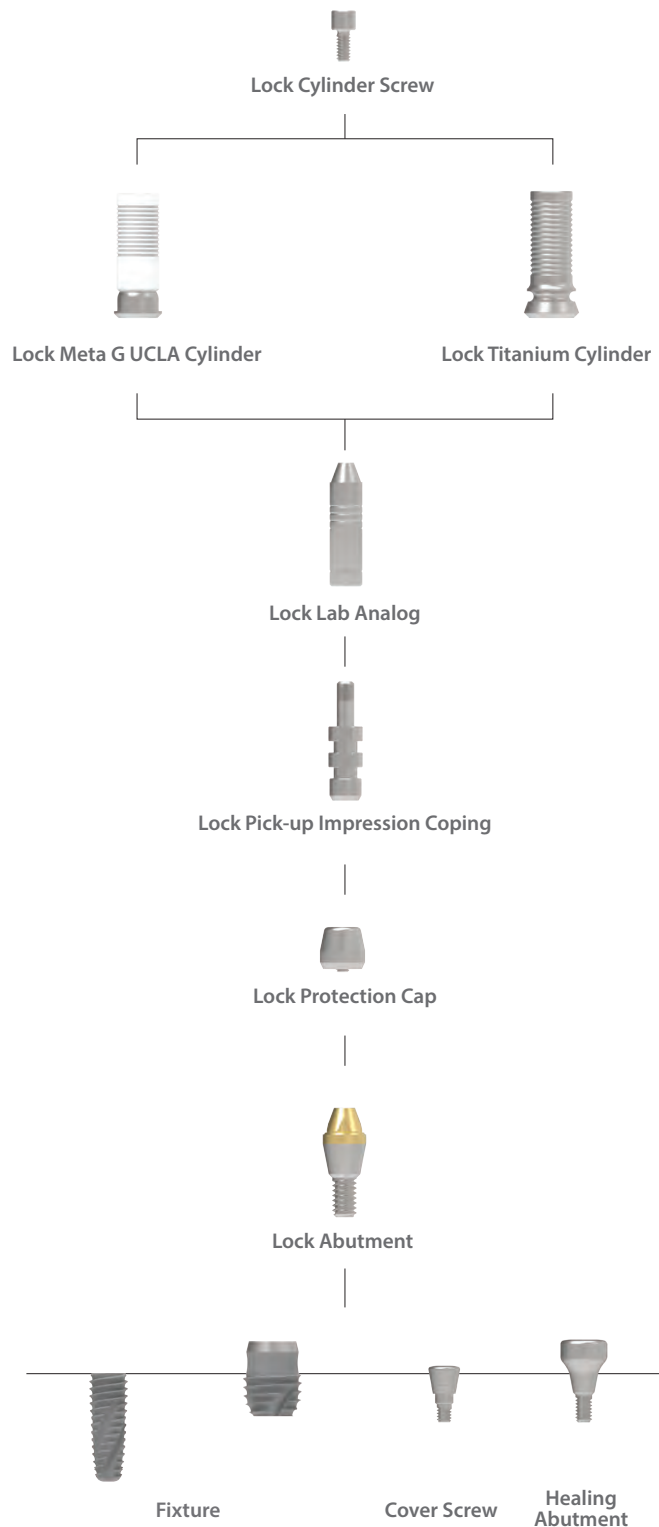

Lock Abutment

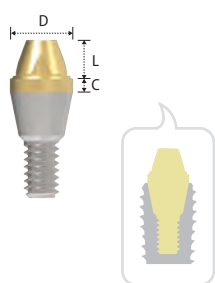

Diameter	Ø3.5
Length	2.15
Cuff	
0.5	2SLA400
1	2SLA410
2	2SLA420
3	2SLA430
4	2SLA440

- > Packing unit: 1 Lock Abutment.
- > For Screw-Retained Prosthesis.
- > Titanium base for the cylinders.
- > Gold color for more translucent restoration.
- > Integrated with screw and abutment.
- > Tightened with the Lock Ratchet Driver and Torque Wrench.
- > Tightening torque force: 30N.cm.
- > Abutment level impression.

Lock Protection Cap



Lock Abutment Diameter	Ø3.5
Diameter	Ø4.3
Height	
4	2SLP45

- > Packing unit: 1 Lock Protection Cap.
- > Protection from cheek and tongue for gingival healing period.
- > Gingival retraction for prosthodontic margin of the abutment.
- > Tightened with the Hex Driver.
- > Tightening torque force: 5~10N.cm.

Lock Pick-up Impression Coping

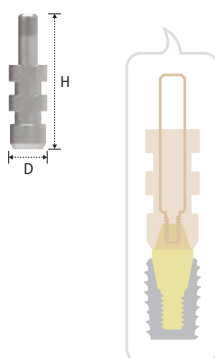

Lock Abutment Diameter	Ø3.5
Diameter	Ø4.3
Height	
16	2SLIH45

- > Packing unit: 1 Lock Pick-up Impression Coping + 1 Guide Pin.
- > Connected with the Guide Pin (2SLIH45S).
- > For open tray impression.

Lock Lab Analog



Lock Abutment Diameter	Ø3.5
Diameter	Ø3.5
Length	2SLA45

- > Packing unit: 1 Lock Lab Analog.
- > Replacement of abutment shape in working cast.
- > Tightened with the Hex Driver and Torque Wrench.

Lock Meta G UCLA Cylinder

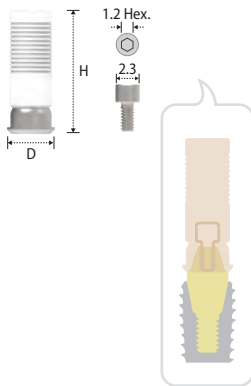

Lock Abutment Diameter	Ø3.5
Diameter	Ø4.3
Height	2SLCH45

- > Packing unit : 1 Lock Meta G UCLA Cylinder + 1 Lock Cylinder Screw.
- > For Screw, Cement, or Screw-Cement Retained Prosthesis.
- > Modification to various types of abutments.
- > CCM alloy core for precise connection.
- > Cast with non-precious metal or gold alloy.
- > Connected with the Lock Cylinder Screw (2SLCS200).
- > Tightened with the Hex Driver and Torque Wrench.
- > Tightening torque force: 30N.cm.

Lock Titanium Cylinder

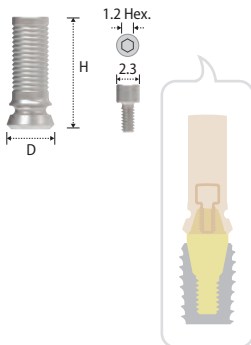

Lock Abutment Diameter	Ø3.5
Diameter	Ø4.3
Height	2SLTH45

- > Packing unit: 1 Lock Titanium Cylinder + 1 Lock Cylinder Screw.
- > For Screw, Cement, or Screw-Cement Retained Prosthesis.
- > Connected with the Lock Cylinder Screw (2SLCS200).
- > Tightened with the Hex Driver and Torque Wrench.
- > Tightening torque force : 30N.cm.

Lock Cylinder Screw

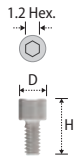

Diameter	Ø2.3
Height	2SLCS200
4.8	

- > Packing unit: 1 Lock Cylinder Screw.
- > Connected with the CCM Cylinder and Titanium Cylinder.
- > Tightened with the Hex Driver and Torque Wrench.
- > Tightening torque force: 30N.cm.

Lock Ratchet Driver

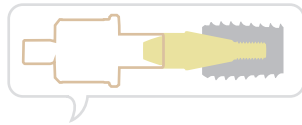

Type	Ratchet
Height	KRLRD18
14.2	
28.5	KRLRD28

- > Packing unit: 1 Lock Ratchet Driver.
- > To install and remove the Lock Abutment with the Torque Wrench.



Prosthetic Procedure IV

Component Selection Guide for Absolute Abutment

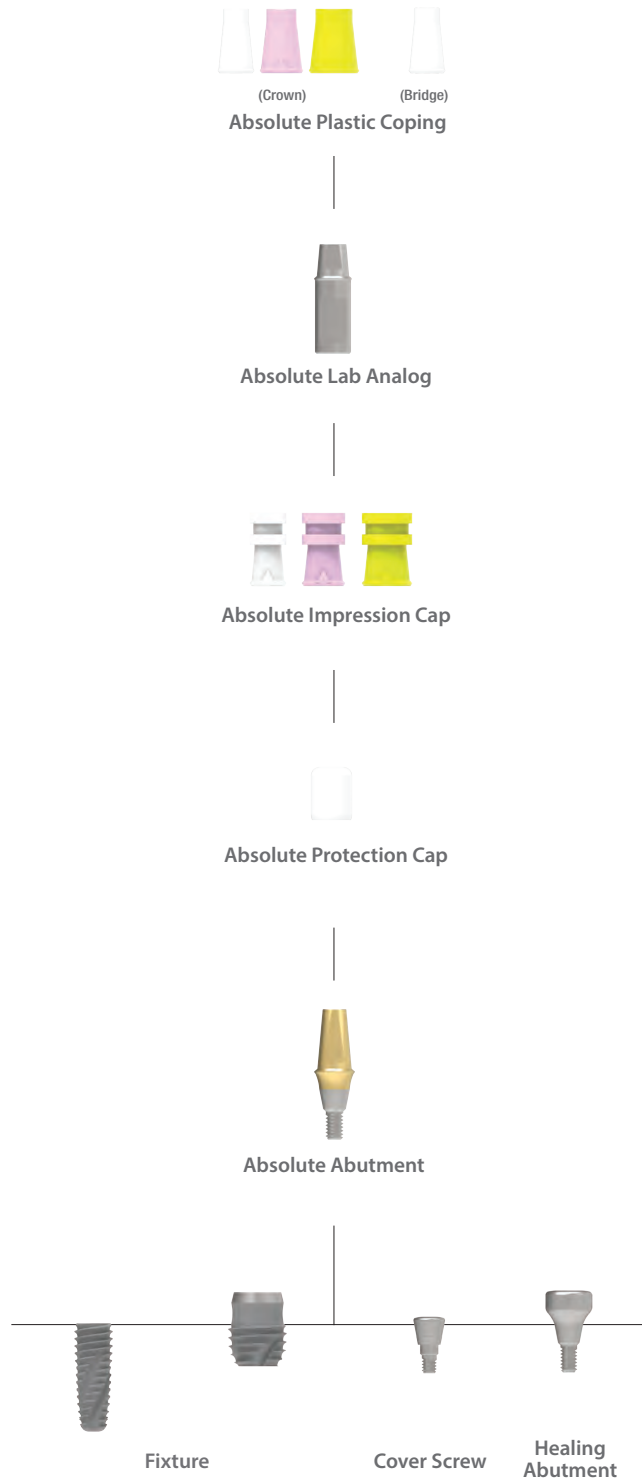

Absolute Abutment

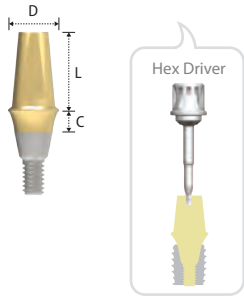

Diameter	Ø4.5			Ø5.5			Ø6.5		
Length / Cuff	4	5.5	7	4	5.5	7	4	5.5	7
1	2SAC4514	2SAC4515	2SAC4517	2SAC5514	2SAC5515	2SAC5517	2SAC6514	2SAC6515	2SAC6517
2	2SAC4524	2SAC4525	2SAC4527	2SAC5524	2SAC5525	2SAC5527	2SAC6524	2SAC6525	2SAC6527
3	2SAC4534	2SAC4535	2SAC4537	2SAC5534	2SAC5535	2SAC5537	2SAC6534	2SAC6535	2SAC6537
4	2SAC4544	2SAC4545	2SAC4547	2SAC5544	2SAC5545	2SAC5547	2SAC6544	2SAC6545	2SAC6547
5	2SAC4554	2SAC4555	2SAC4557	2SAC5554	2SAC5555	2SAC5557	2SAC6554	2SAC6555	2SAC6557

- > Packing unit: 1 Absolute Abutment + 1 Protection Cap.
- > For Cement Retained Prosthesis.
- > Cutting surface for anti-rotation of the prosthesis.
- > Integrated with the Screw and Abutment.
- > Tightened with the Hex Driver or the Absolute Ratchet Driver and Torque Wrench.
- > Tightening torque force: 30N.cm.
- > Abutment level impression.

Absolute Ratchet Driver

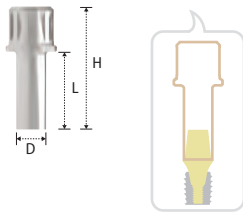

Diameter	Ø4.6		Ø5.6		Ø6.6	
Length / Height	12	19	12	19	12	19
19	KRAD4512S		KRAD5512S		KRAD6512S	
26		KRAD4519L		KRAD5519L		KRAD6519L

- > Packing unit: 1 Absolute Ratchet Driver.
- > To install and remove the Absolute with the Torque Wrench.

Absolute Protection Cap

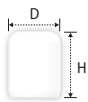

Absolute Abutment Diameter	Ø4.5	Ø5.5	Ø6.5
Diameter / Height	Ø5.0	Ø6.0	Ø7.0
6	2SHPC454	2SHPC554	2SHPC654
7.5	2SHPC455	2SHPC555	2SHPC655
9	2SHPC457	2SHPC557	2SHPC657

- > Packing unit: 1 Absolute Protection Cap.
- > Protection from cheek and tongue for gingival healing period.
- > Gingival retraction for prosthodontic margin of the abutment.
- > Alternative usage for sub-structure of the temporary prosthesis.

Absolute Impression Cap



Absolute Abutment Diameter	Ø4.5	Ø5.5	Ø6.5
Diameter / Height	Ø5.5	Ø6.5	Ø7.5
10.3	2SIC45	2SIC55	2SIC65

- > Packing unit: 1 Absolute Impression Cap.
- > Confirm locking with abutment by rotation of clockwise and anti-clockwise direction.

Absolute Lab Analog



Absolute Abutment Diameter	Ø4.5	Ø5.5	Ø6.5
Diameter / Length	Ø4.5	Ø5.5	Ø6.5
4.1	2SHLA454	2SHLA554	2SHLA654
5.6	2SHLA455	2SHLA555	2SHLA655
7.1	2SHLA457	2SHLA557	2SHLA657

- > Packing unit: 1 Absolute Lab Analog.
- > Replacement of abutment shape in working cast.
- > Choose according to width and length of the abutment.

Absolute Plastic Coping (Burn Out Cylinder)

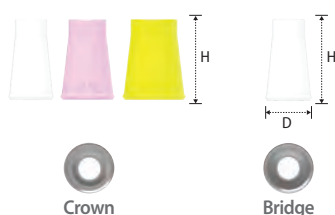

Type	Crown			Bridge		
Absolute Abutment Diameter	Ø4.5	Ø5.5	Ø6.5	Ø4.5	Ø5.5	Ø6.5
Diameter / Height	Ø5.1	Ø6.1	Ø7.1	Ø5.1	Ø6.1	Ø7.1
10	2SHBC45	2SHBC55	2SHBC65	2SHBB45	2SHBB55	2SHBB65

- > Packing unit: 1 Absolute Plastic Coping.
- > Connected with the Lab Analog.
- > Burn out and casting for the metal framework.

Prosthetic Procedure V

Component Selection Guide for Straight Abutment

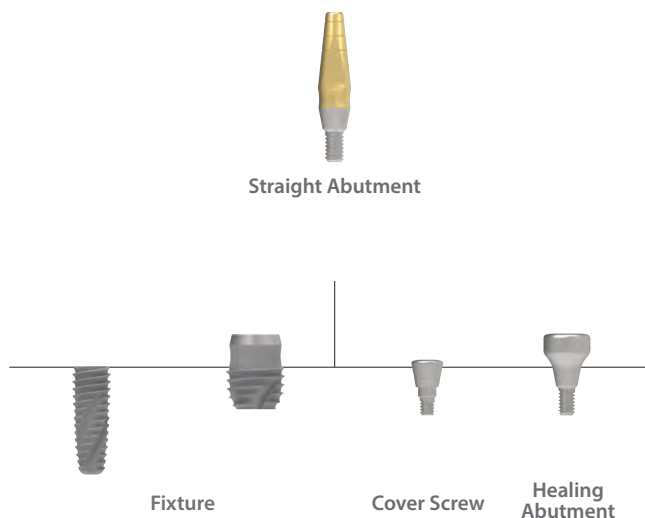

Straight Abutment

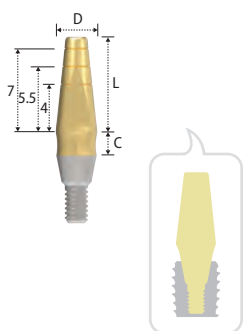

Diameter	Ø3.5	Ø4.5
Length Cuff	8	8
0.5	2SSCM308	2SSCR408
1	2SSCM318	2SSCR418
2	2SSCM328	2SSCR428
3	2SSCM338	2SSCR438
4	2SSCM348	2SSCR448

- > Packing unit: 1 Straight Abutment.
- > For Cement Retained Prosthesis.
- > Integrated with screw and abutment.
- > Tightened with the Shoulder Driver.
- > Tightening torque force: 30N.cm.
- > Direct impression.

Shoulder Ratchet Driver

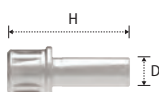

Diameter Height	Ø3.5	Ø4.5
19	KRR12S, KRR19L	KRW12S, KRW19L

- > Packing unit: 1 Shoulder Ratchet Driver
- > To install and remove the Straight Abutment with the Torque Wrench.

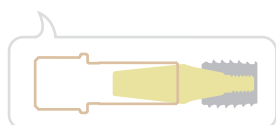

Prosthetic Procedure VI

Component Selection Guide for Sonator S&A Abutment

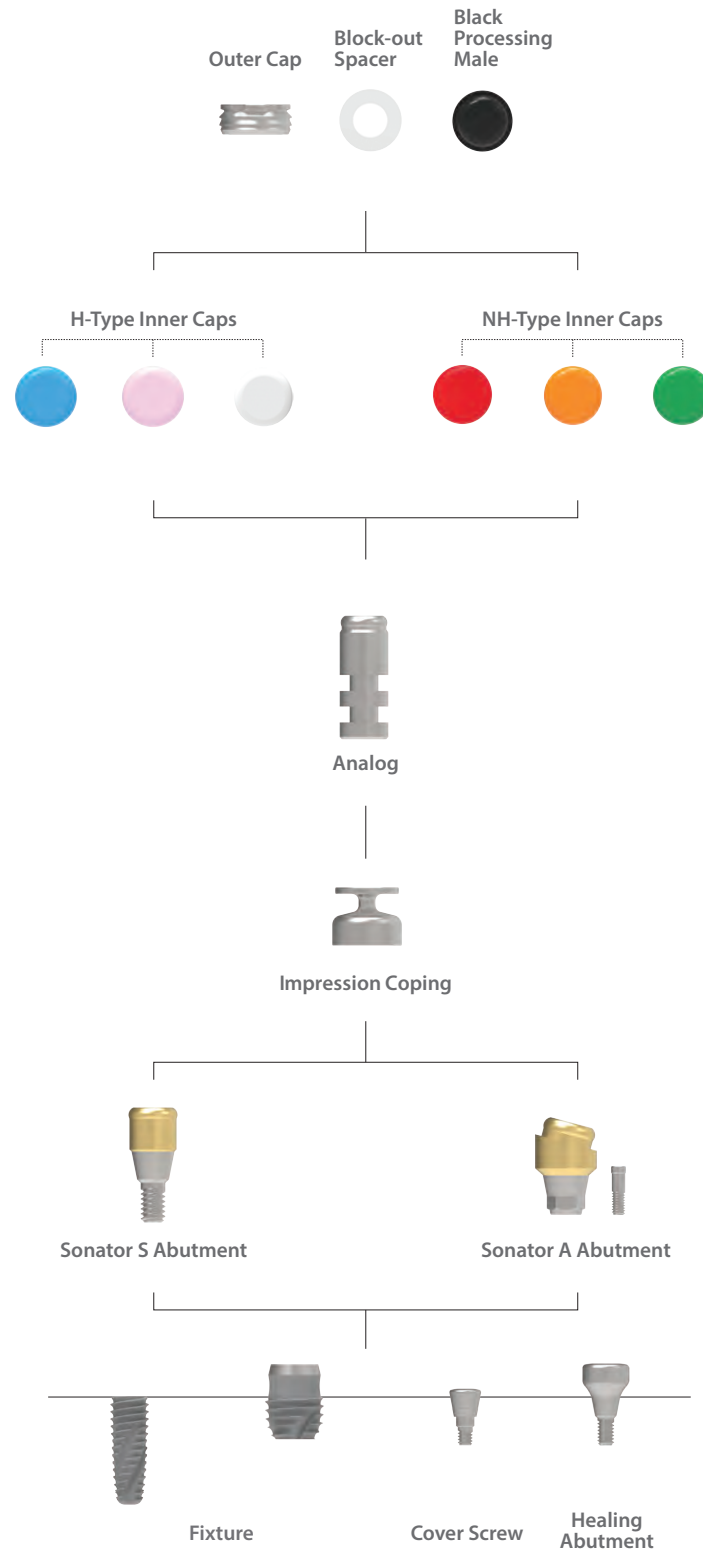

Sonator S Abutment

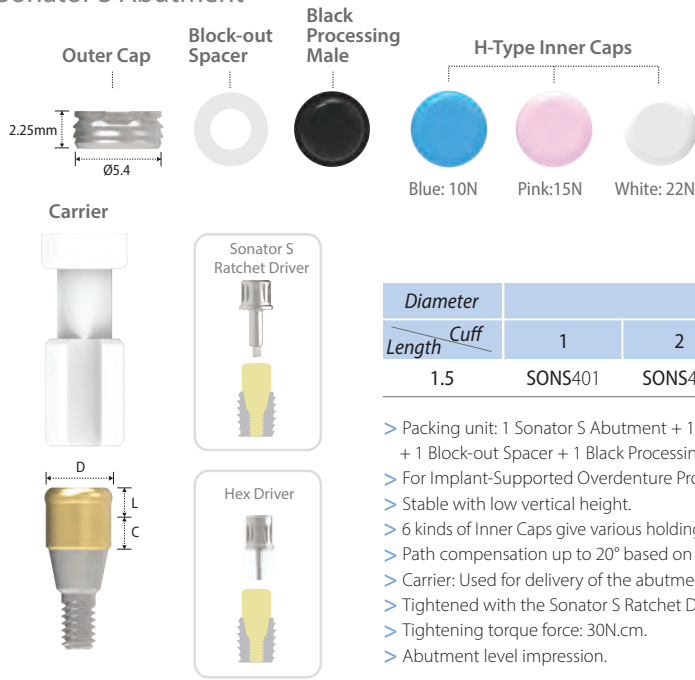

Diameter	Ø4.0					
Length / Cuff	1	2	3	4	5	6
1.5	SONS401	SONS402	SONS403	SONS404	SONS405	SONS406

- > Packing unit: 1 Sonator S Abutment + 1 Carrier + 3 H-Type Inner Caps + 1 Outer Cap + 1 Block-out Spacer + 1 Black Processing Male.
- > For Implant-Supported Overdenture Prosthesis.
- > Stable with low vertical height.
- > 6 kinds of Inner Caps give various holding force (Both, H and NH-Type Inner Caps are used for the Sonator S Abutment).
- > Path compensation up to 20° based on 2 implants.
- > Carrier: Used for delivery of the abutment.
- > Tightened with the Sonator S Ratchet Driver or Hex Driver and Torque Wrench.
- > Tightening torque force: 30N.cm.
- > Abutment level impression.

Sonator A Abutment

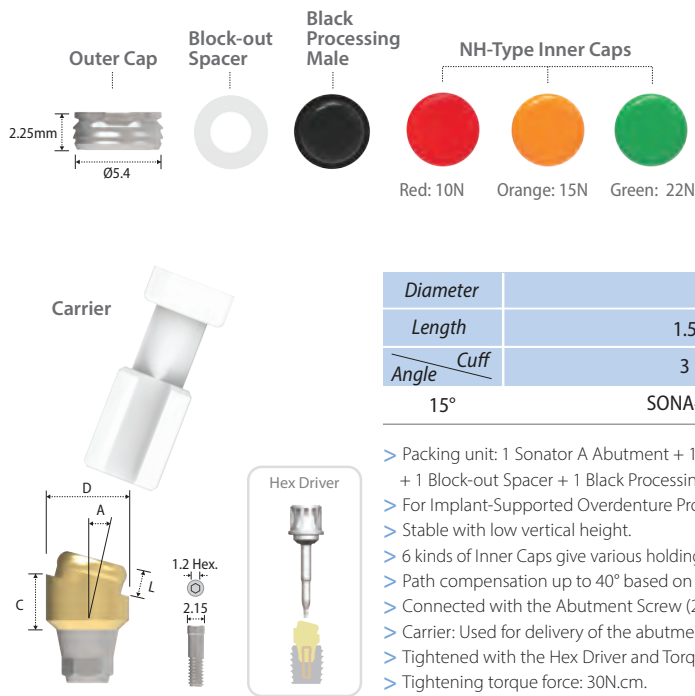

Diameter	Ø4.0	
Length	1.5	3.0
Angle / Cuff	3	3
15°	SONA415	SONA430

- > Packing unit: 1 Sonator A Abutment + 1 Abutment Screw + 1 Carrier + 3 NH-Type Inner Caps + 1 Outer Cap + 1 Block-out Spacer + 1 Black Processing Male.
- > For Implant-Supported Overdenture Prosthesis.
- > Stable with low vertical height.
- > 6 kinds of Inner Caps give various holding force (Both, H and NH-Type Inner Caps are used for the Sonator A Abutment).
- > Path compensation up to 40° based on 2 Implants.
- > Connected with the Abutment Screw (2SSHR300).
- > Carrier: Used for delivery of the abutment.
- > Tightened with the Hex Driver and Torque wrench.
- > Tightening torque force: 30N.cm.
- > Abutment level impression.

Abutment Screw

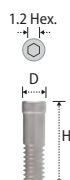

Diameter / Height	Ø2.15
7.5	2SSHR300

- > Packing unit: 1 Abutment Screw.
- > To connect the Sonator A Abutment.
- > Tighten with the Hex Driver and Torque Wrench.

Outer Cap

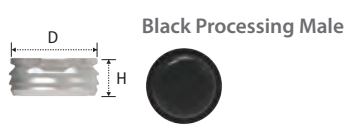

<i>Diameter</i>	Ø5.4
<i>Height</i>	SONOC01
2.25	

- > Packing unit: 2 Outer Caps and 2 Black Processing Males.
- > Black Processing Male: Inserted and removed with the I&R Driver.

H-Type Inner Cap

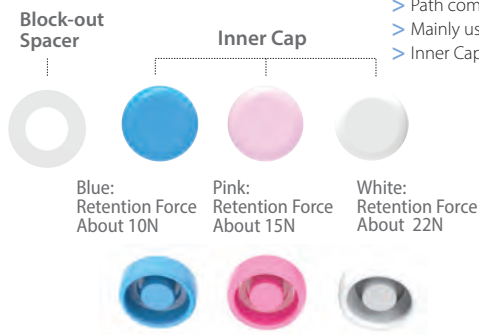

<i>Code</i>	SONIC01
-------------	---------

- > Packing unit: 3 Block-out Spacers + 3 Inner Caps (1 Blue, 1 Pink, and 1 White).
- > Path compensation up to 20° based on 2 implants.
- > Mainly used for the Sonator S Abutment.
- > Inner Caps: Inserted and removed with the I&R Driver.

NH-Type Inner Cap

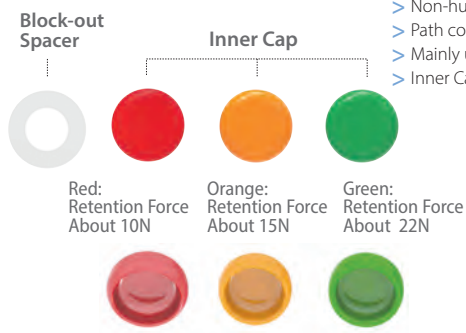

<i>Code</i>	SONIC02
-------------	---------

- > Packing unit: 3 Block-out Spacers + 3 Inner Caps (1 Red, 1 Orange, and 1 Green).
- > Non-humped design.
- > Path compensation up to 40° based on 2 implants.
- > Mainly used for the Sonator A Abutment.
- > Inner Caps: Inserted and removed with the I&R Driver.

Sonator Impression Coping

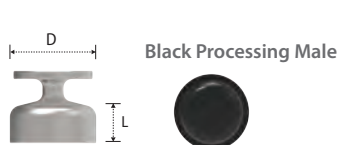

<i>Diameter</i>	Ø4.8
<i>Length</i>	SONIP04
3	

- > Packing unit: 4 Sonator Impression Copings and 4 Black Processing Males.
- > Connected over the Sonator S&A Abutment after placing the Block-out Spacer.
- > For close tray impression.

Sonator Lab Analog



<i>Diameter</i>	Ø4
<i>Length</i>	SONLA04
1.4	

- > Packing unit: 4 Sonator Lab Analogs.
- > Replacement of abutment shape in working cast.

Sonator S Ratchet Driver

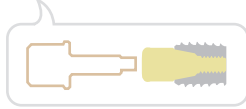
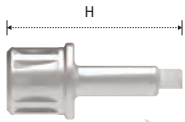

<i>Type</i>	Ratchet
<i>Height</i>	SONRD19L
18	

- > Packing unit : 1 Sonator S Ratchet Driver.
- > To install and remove the Sonator S Abutment with the Torque Wrench.

Sonator I&R Driver

<i>Height</i>	95.4
	SONIR002

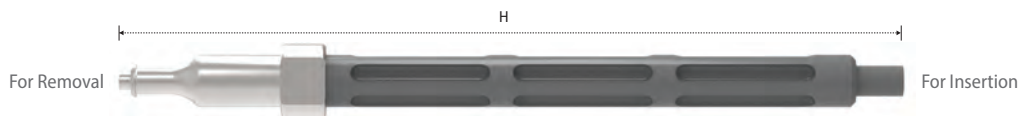

- > Packing unit: 1 Sonator I&R Driver.
- > Used to insert and remove the Inner Caps and Block Processing Male.

Prosthetic Procedure VII

Component Selection Guide for Ball Abutment

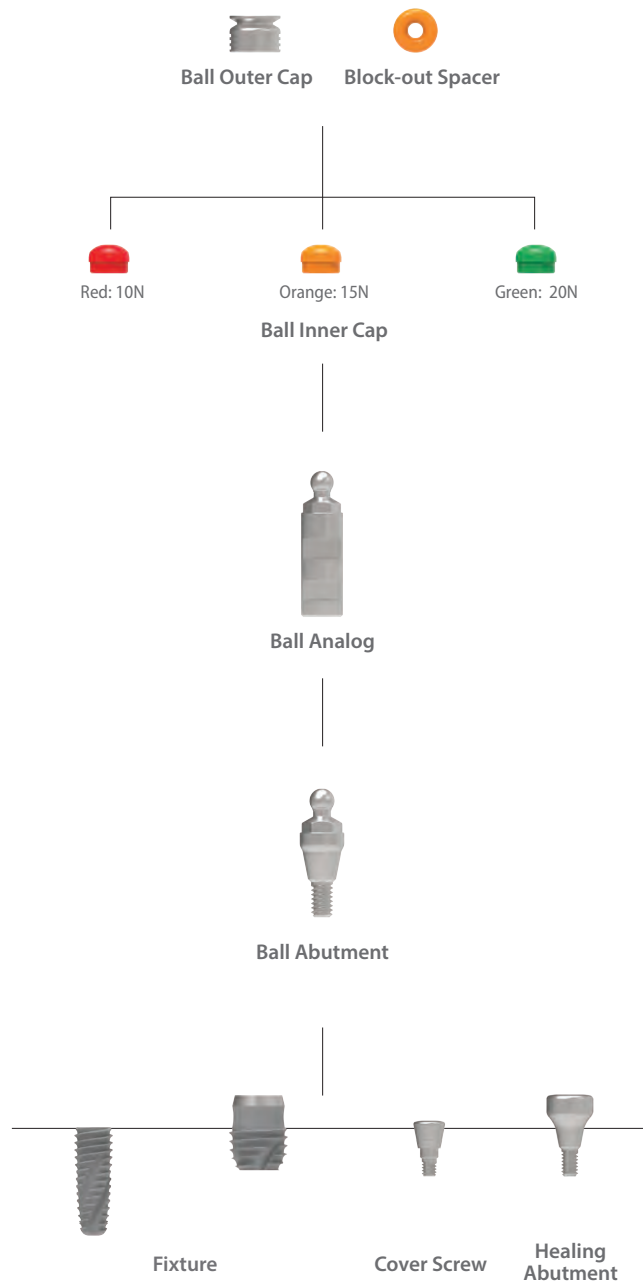

Ball Abutment

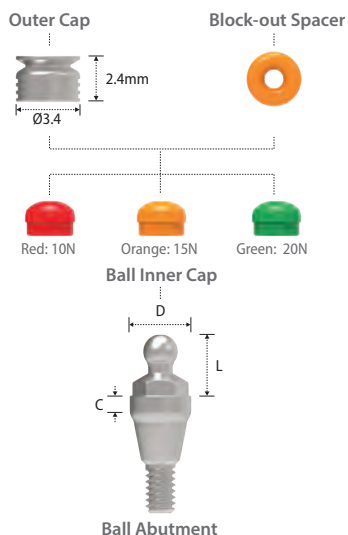

<i>Diameter</i>	Ø4.0
<i>Length</i> <i>Cuff</i>	4
1	2SBAT414R
2	2SBAT424R
3	2SBAT434R
4	2SBAT444R
5	2SBAT454R

- > Packing unit: 1 Ball Abutment + 3 Inner Caps (1 per each colour) + 1 Block-out Spacer + 1 Outer Cap.
- > For Implant-Supported Overdenture Prosthesis.
- > Tightened with the Ball Driver and Torque Wrench.
- > Tightening torque force: 30N.cm.
- > Direct impression.

Ball Outer Cap

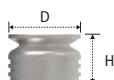

<i>Diameter</i> <i>Height</i>	Ø3.4 2.4
	BATC003C

- > Packing unit: 2 Outer Caps.

Ball Inner Cap

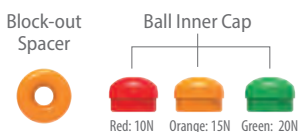

	BATC003I
--	----------

- > Packing unit: 2 Block-out Spacers + 6 Inner Caps (2 per each color).
- > Retention force: Red 10N, Orange 15N & Green 20N.

Ball Analog



<i>Diameter</i> <i>Length</i>	Ø4.0 4
	SBAL400

- > Packing unit: 4 Lab Analogs.
- > Replacement of abutment shape in working cast.

Ball Ratchet Driver

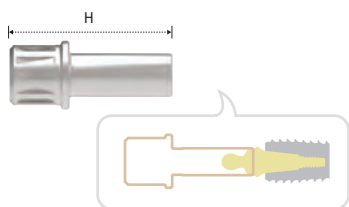

<i>Type</i> <i>Height</i>	Ratchet 19
	KRB19L

- > Packing unit: 1 Ball Ratchet Driver
- > To install and remove the Ball Abutment with the Torque Wrench. *Extra Product

Ball I&R Driver

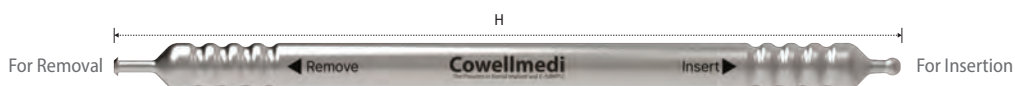





<i>Height</i>	100
	KBIR01

- > Packing unit: 1 Ball I&R Driver.
- > Used to insert and remove the Inner Caps into and out of the Outer Cap.

INNO SUBMERGED NARROW IMPLANT (Sub-N.)

System Flow

Fixture	Abutment	
	<p>Prosthetic Procedure I</p>	 <p>Cemented Abutment Angulated Abutment Temporary Abutment</p>
	<p>Prosthetic Procedure II</p>	 <p>Straight Abutment</p>

Impression	
Fixture Level Impression	 <p>Replica</p> <p>Pick-up Impression Coping</p> <p>Transfer Post</p>
Abutment Level Impression	Direct Impression

INNO Submerged Narrow Implant (Sub-N.)



Submerged Fixture

Surface Treatment: **SLA-SH**

- > Interchangeable with hexagonal morse tapered fixture
- > Internal hex connection (Taper 11°/ Hex 2.1)

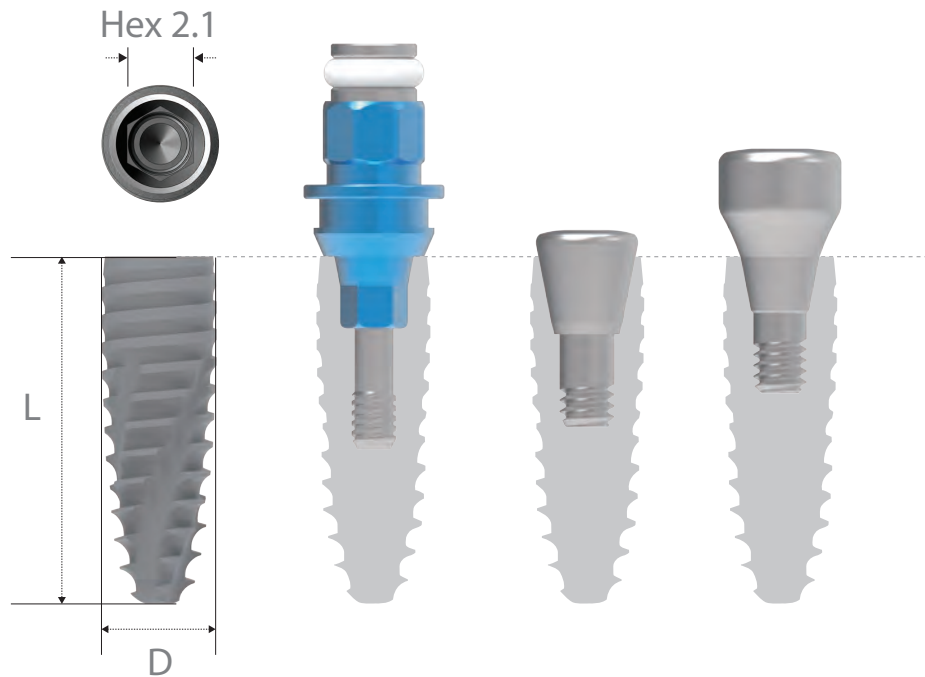

No-Mount > Packing unit: 1 Fixture + 1 Cover Screw.

Diameter (Actual Size) **Ø3.1 (Ø3.3)**
Length (Actual Size)

8 (8.5)	SR3108NSM
10	SR3110NSM
12	SR3112NSM
14	SR3114NSM

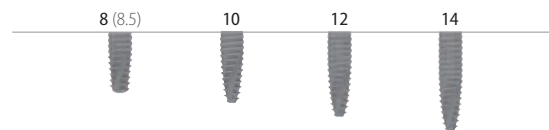

Diameter (Actual Size) **Ø3.3 (Ø3.5)**
Length (Actual Size)

8 (8.5)	SR3308NSM
10	SR3310NSM
12	SR3312NSM
14	SR3314NSM

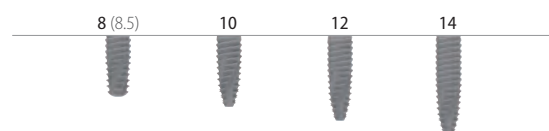

Pre-Mount > Packing unit: 1 Fixture + 1 Cover Screw + 1 Mount.

Diameter (Actual Size)	Ø3.1 (Ø3.3)
Length (Actual Size)	
8 (8.5)	SR3108NS
10	SR3110NS
12	SR3112NS
14	SR3114NS

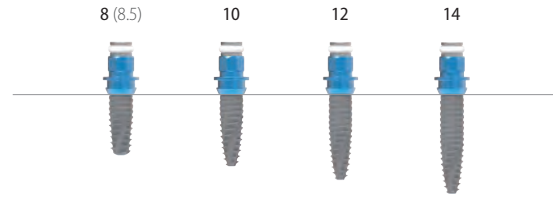

Diameter (Actual Size)	Ø3.3 (Ø3.5)
Length (Actual Size)	
8 (8.5)	SR3308NS
10	SR3310NS
12	SR3312NS
14	SR3314NS

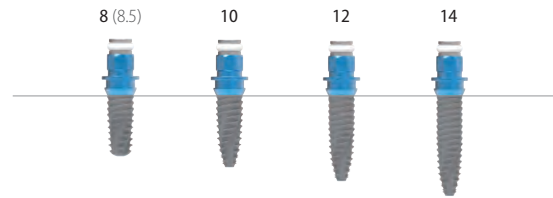
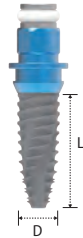

Fixture Mount

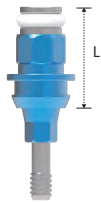

Length	5.4
	RSM001

- > Packing unit: 1 Mount + 1 Mount Screw.
- > Tightened with the Hex Driver.
- > Tightening torque force: 5~10N.cm.

Cover Screw

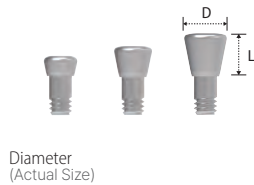

Diameter / Length	Ø2.85	Ø3.25	Ø3.6
1.7	RCS000		
2.7		RCS001	
3.7			RCS002

- > Packing unit: 1 Cover Screw.
- > To seal the conical interface of the fixture.
- > The longer the Cover Screw for the deeply inserted fixture.
- > Tightened with the Hex Driver.
- > Tightening torque force: 5~10N.cm.

Healing Abutment

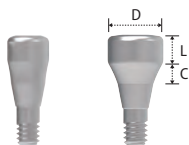

Diameter	Ø3.5		Ø4.5	
Cuff / Length	1	2	1	2
0.5	HR3501			
1	HR3511		HS4511N	
2		HR3522		HS4522N
3		HR3532		HS4532N
4		HR3542		HS4542N
5				HS4552N
7				HS4572N

- > Packing unit: 1 Healing Abutment.
- > For remodeling gingival contour during soft tissue healing.
- > Select the abutment according to gingival height and abutment type.
- > Tightened with the Hex Driver.
- > Tightening torque force: 5~10N.cm.

Prosthesis Procedure I

Components Selection Guide for Cemented and UCLA Abutment

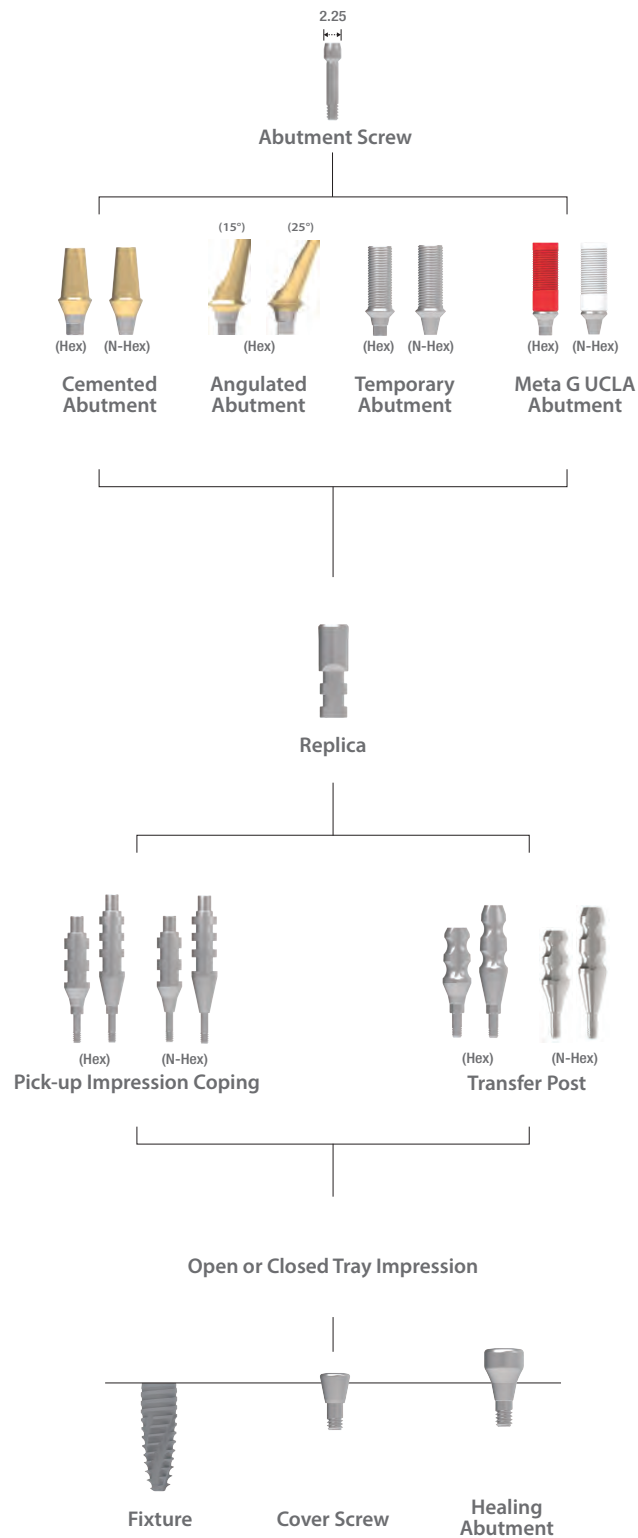

Cemented Abutment

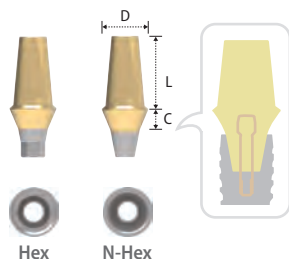

Type	Hex			N-Hex		
Diameter	Ø4.5			Ø4.5		
Length / Cuff	4	5.5	7	4	5.5	7
1	SCH4514N	SCH4515N	SCH4517N	SCN4514N	SCN4515N	SCN4517N
2	SCH4524N	SCH4525N	SCH4527N	SCN4524N	SCN4525N	SCN4527N
3	SCH4534N	SCH4535N	SCH4537N	SCN4534N	SCN4535N	SCN4537N
4	SCH4544N	SCH4545N	SCH4547N	SCN4544N	SCN4545N	SCN4547N
5	SCH4554N	SCH4555N	SCH4557N	SCN4554N	SCN4555N	SCN4557N

- > Packing unit: 1 Cemented Abutment + 1 Abutment Screw.
- > For Screw-Cement or Cement Retained Prosthesis.
- > Cutting surface for anti-rotation of the prosthesis.
- > Gold color for more translucent restoration.
- > Library available for EXOCAD®, 3Shape® & Others.
- > Connected with the Abutment Screw (SSHR100N).
- > Tightened with the Hex Driver and Torque Wrench.
- > Tightening torque force: 20~25N.cm.
- > Use the Scanbody for 3D Work.
- > Fixture level impression.

Angulated Abutment

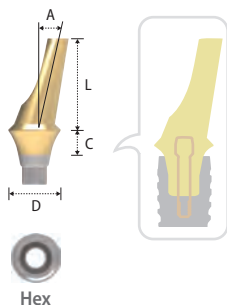

Type	Hex	
Diameter(Angle)	Ø4.5(15°)	Ø4.5(25°)
Length / Cuff	8	8
1	SAH45151NA	SAH45251NA
2	SAH45152NA	SAH45252NA
3	SAH45153NA	SAH45253NA
4	SAH45154NA	SAH45254NA

- > Packing unit: 1 Angulated Abutment + 1 Abutment Screw.
- > For Screw-Cement or Cement Retained Prosthesis.
- > Solution for the anterior esthetic zone.
- > Gold color for esthetics.
- > Connected with the Abutment Screw (SSHR100N).
- > Tightened with the Hex Driver and Torque Wrench.
- > Tightening torque force: 20~25N.cm.
- > Fixture level impression.

Temporary Abutment

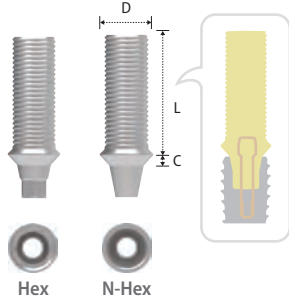

Type	Hex	N-Hex
Diameter	Ø4.5	Ø4.5
Length / Cuff	10	10
1	STHA45N	STNA45N

- > Packing unit: 1 Temporary Abutment + 1 Abutment Screw.
- > For Screw-Cement Retained Prosthesis.
- > For provisional restoration.
- > Connected with the Abutment Screw (SSHR100N).
- > Tightened with the Hex Driver and Torque Wrench.
- > Tightening torque force: 20~25N.cm.

Meta G UCLA Abutment

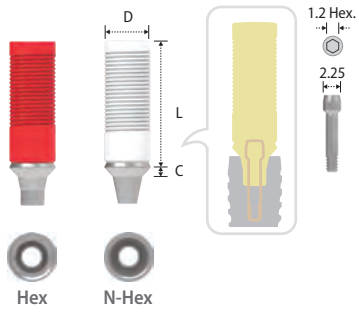

Type	Hex	N-Hex
Diameter	Ø4.5	Ø4.5
Length Cuff	12	12
1	SGH45N	SGN45N
2	SGH452N	SGN452N
3	SGH453N	SGN453N

- > Packing unit: 1 Meta G UCLA Abutment + 1 Abutment Screw.
- > For Screw Retained Prosthesis.
- > Modification to the angulated abutment, customized abutment and telescopic abutment.
- > CCM alloy core for precise connection.
- > Cast with non-precious metal or gold alloy.
- > Connected with the Abutment Screw (SSHR100N).
- > Tightened with the Hex Driver and Torque Wrench.
- > Tightening torque force: 20~25N.cm.
- > Fixture level impression.

Abutment Screw

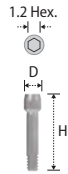

Diameter Height	2.25
10.2	SSHR100N

- > Packing unit: 1 Abutment Screw.
- > Tightened with the Hex Driver and Torque Wrench.
- > Tightening torque force: 20~25N.cm.

Replica

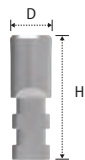

Diameter Height	Ø4.0
12.1	SRHR001N

- > Packing unit: 1 Replica.
- > Mimicking of the conical interface of the fixture.
- > Analog of fixture for the working cast.

Pick-up Impression Coping

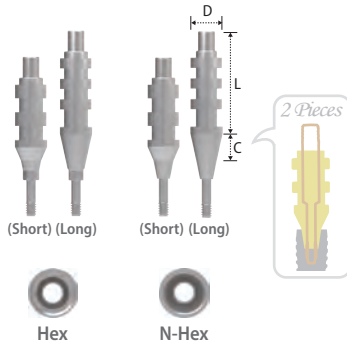

Type	Hex	N-Hex
<i>Diameter</i>	Ø4.5	Ø4.5
<i>Length / Cuff</i>		
14 (Short) / 2	SIH45SN	SIN45SN
16 (Long) / 4	SIH45LN	SIN45LN

- > Packing unit: 1 Pick-up Impression Coping + 1 Guide Pin.
- > For open tray impression.
- > Connected with the Guide Pin (SIS001SN / SIS001LN).
- > Tightened with the Hex Driver and Torque Wrench.
- > Tightening torque force: 12~15Ncm.

Transfer Post

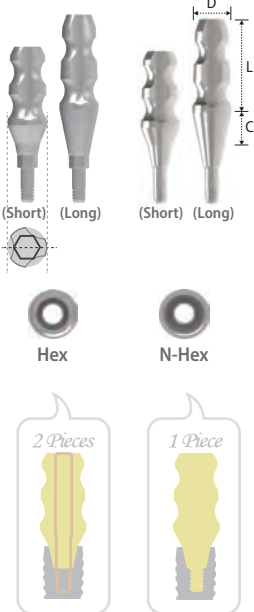

Type	Hex	N-Hex
<i>Diameter</i>	Ø4.5	Ø4.5
<i>Length / Cuff</i>		
9 (Short) / 2	STH45SN	STN45SN
11 (Long) / 4	STH45LN	STN45LN

- > Packing unit: Hex - 1 Transfer Post + 1 Guide Pin / N-Hex - 1 Transfer Post (Solid Type).
- > For closed tray impression.
- > Connected with the Guide Pin (STH001SN / STH001LN).
- > Tightened with the Hex Driver and Torque Wrench.
- > Tightening torque force: 12~15Ncm.

Prosthesis Procedure II

Component Selection Guide for Multi S&A Abutment

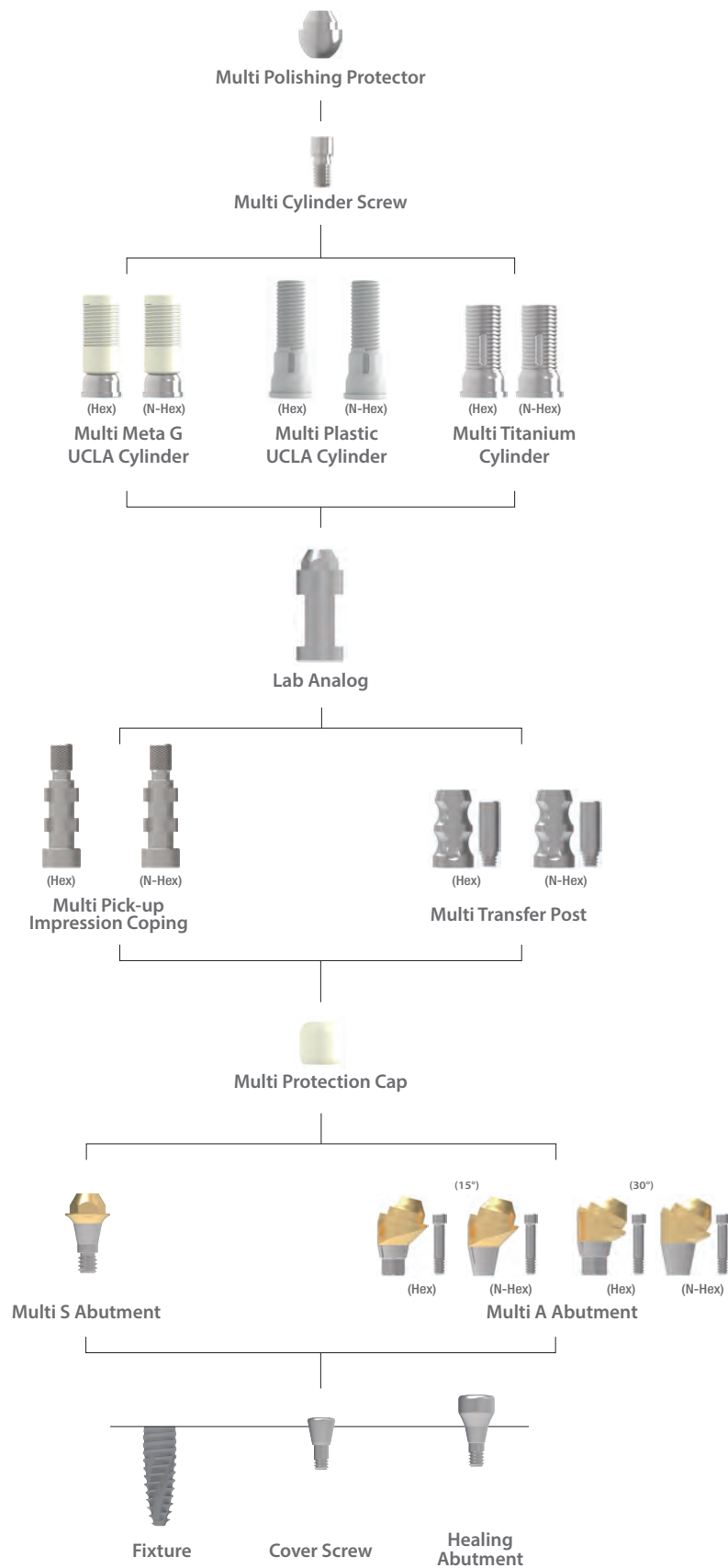

Multi S Abutment

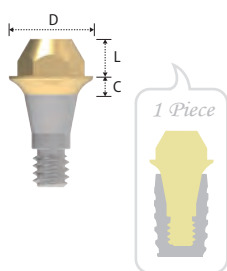

Diameter	Ø4.5
Cuff / Length	2
1	SMS451N
2	SMS452N
3	SMS453N
4	SMS454N

- > Packing unit: 1 Multi S Abutment.
- > For Screw-Retained Prosthesis.
- > Titanium base for the cylinders.
- > Gold color for more translucent restoration.
- > Integrated with screw and abutment.
- > Library available for EXOCAD®, 3Shape® & Others.
- > Use the S Holder for a more stable position.
- > Tightened with the S Machine & S Ratchet Driver and Torque Wrench.
- > Tightening torque force: 20~25N.cm.
- > Abutment level impression.

Multi A Abutment

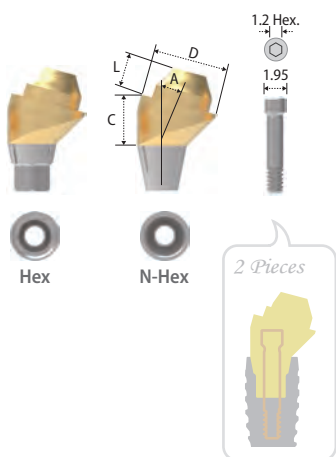

Type	Hex	
Diameter(Angle)	Ø4.5(15°)	Ø4.5(30°)
Cuff / Length	2	2
2	★ SMAH45152N	
3	● SMAH45153N	★ SMAH45303N
4	● SMAH45154N	● SMAH45304N

Type	N-Hex	
Diameter(Angle)	Ø4.5(15°)	Ø4.5(30°)
Cuff / Length	2	2
2	★ SMAN45152N	
3	● SMAN45153N	★ SMAN45303N
4	● SMAN45154N	● SMAN45304N

- > Packing unit: 1 Multi A Abutment + 1 Abutment Screw.
- > For Screw-Retained Prosthesis.
- > Titanium base for the cylinders.
- > Gold color for more translucent restoration.
- > Library available for EXOCAD®, 3Shape® & Others.
- > Use the A Holder for a more stable position.
- > Connected with the Abutment Screw (SSHR200N: ★ / SSHR300N: ●).
- > Tightened with the Hex Driver and Torque Wrench.
- > Tightening torque force: 20~25N.cm.
- > Abutment level impression.

Abutment Screw



Height	8.7	9.3
Diameter	Ø1.95	● SSHR300N
	★ SSHR200N	

- > Packing unit: 1 Abutment Screw.
- > To connect the Multi A Abutment.
- > Tightened with the Hex Driver and Torque Wrench.

Multi Protection Cap

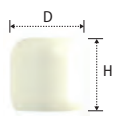

Multi S & A Abutment Diameter	Ø4.5
Diameter	Ø5.2
Height	5
2SMPC45	

- > Packing unit: 1 Multi Protection Cap.
- > Protection from cheek and tongue for gingival healing period.
- > Gingival retraction for prosthodontic margin of the abutment.
- > Alternative usage for sub-structure of the temporary prosthesis.
- > Tightened with the Hex Driver.
- > Tightening torque force: 5~10N.cm.

Multi Pick-up Impression Coping

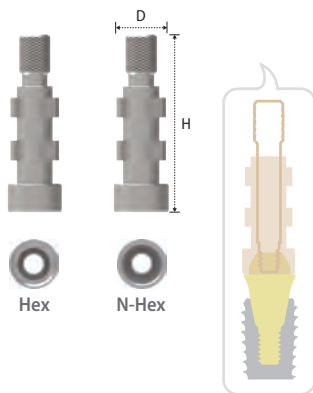

Type	Hex	N-Hex
Multi S & A Abutment Diameter	Ø4.5	Ø4.5
Diameter	Ø4.65	Ø4.65
Height	16	16
2SMIH45		2SMIN45

- > Packing unit: 1 Multi Pick-up Impression Coping + 1 Guide Pin.
- > For open tray impression.
- > Connected with the Guide Pin (2SMGP012).
- > Tightened with the Hex Driver and Torque Wrench.
- > Tightening torque force: 12~15N.cm.

Multi Transfer Post

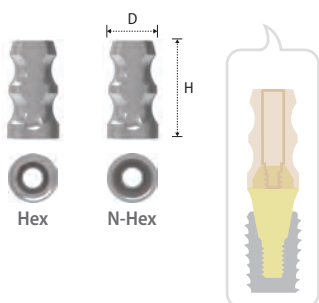

Type	Hex	N-Hex
Multi S & A Abutment Diameter	Ø4.5	Ø4.5
Diameter	Ø4.5	Ø4.5
Height	8.5	8.5
2SMTH45		2SMTN45

- > Packing unit: 1 Multi Transfer Post + 1 Guide Pin.
- > For closed tray impression.
- > Connected with the Guide Pin (2SMTHS100).
- > Tightened with the Hex Driver and Torque Wrench.
- > Tightening torque force: 12~15N.cm.

Multi Lab Analog



Multi S & A Abutment Diameter	Ø4.5
Diameter	Ø4.5
Length	2
	2SMA45

- > Packing unit: 1 Multi Lab Analog.
- > Replacement of abutment shape in working cast.

Multi Meta G UCLA Cylinder

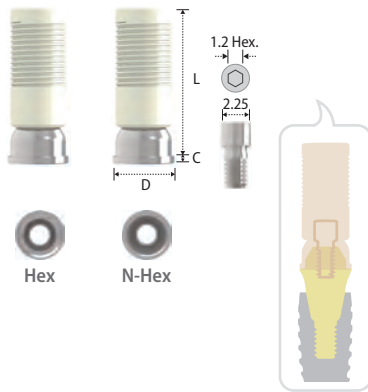

Type	Hex	N-Hex
Multi S & A Abutment Diameter	Ø4.5	Ø4.5
Diameter	Ø4.5	Ø4.5
Length	10.9	10.9
Cuff	0.5	0.5
	2SCCH45	2SCCN45

- > Packing unit: 1 Multi Meta G UCLA Cylinder + 1 Multi Cylinder Screw.
- > For Screw, Cement, or Screw-Cement Retained Prosthesis.
- > Modification to various types of abutments.
- > CCM alloy core for precise connection.
- > Cast with non-precious metal or gold alloy.
- > Connected with the Multi Cylinder Screw (2SMCS100).
- > Tightened with the Hex Driver and Torque Wrench.
- > Tightening torque force: 20N.cm.

Multi Plastic UCLA Cylinder

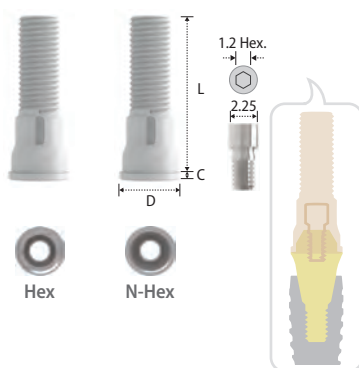

Type	Hex	N-Hex
Multi S & A Abutment Diameter	Ø4.5	Ø4.5
Diameter	Ø4.5	Ø4.5
Length	11.5	11.5
Cuff	0.5	0.5
	2SMPH45	2SMPN45

- > Packing unit: 1 Multi Plastic UCLA Cylinder + 1 Multi Cylinder Screw.
- > For Screw, Cement or Screw-Cement Retained Prosthesis.
- > Same purpose of use as the Meta G UCLA Cylinder but the low accuracy of connection.
- > PMMA material.
- > Connected with the Multi Cylinder Screw (2SMCS100).
- > Tightened with the Hex Driver and Torque Wrench.
- > Tightening torque force: 20N.cm.

Multi Titanium Cylinder

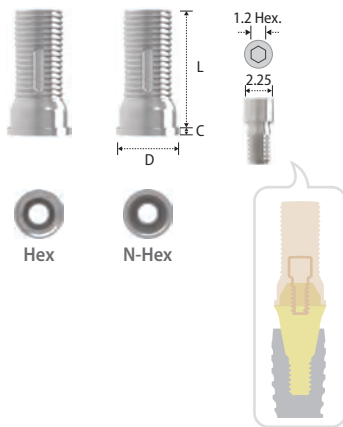

Type	Hex	N-Hex
Multi S & A Abutment Diameter	Ø4.5	Ø4.5
Diameter	Ø4.5	Ø4.5
Length	8.5	8.5
Cuff	0.5	2STCH45
		2STCN45

- > Packing unit: 1 Multi Titanium Cylinder + 1 Multi Cylinder Screw.
- > For Screw, Cement or Screw-Cement Retained Prosthesis.
- > Connected with the Multi Cylinder Screw (2SMCS100).
- > Tightened with the Hex Driver and Torque Wrench.
- > Tightening torque force: 20N.cm.

Multi Cylinder Screw

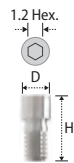

Diameter	Ø2.25
Height	5
	2SMCS100

- > Packing unit: 1 Multi Cylinder Screw.
- > Connected with the Meta G UCLA, Plastic UCLA, and Titanium Cylinder.
- > Tightened with the Hex Driver and Torque Wrench.
- > Tightening torque force: 20N.cm.

Multi Polishing Protector



Type	Hex
Multi S & A Abutment Diameter	Ø4.5
Diameter	Ø4.5
Length	2
	2SMPP45

- > Packing unit: 1 Multi Polishing Protector.
- > To protect margin of the prosthesis while polishing procedure.

Multi Holder

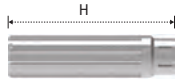

S Holder

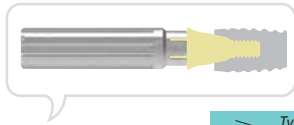

Height	Type	Hand
20		KMHS01

- > Packing unit: 1 Multi S Holder.
- > To position the Multi S Abutment more stably.



A Holder

Height	Type	Hand
32		KMHA01

- > Packing unit: 1 Multi A Holder.
- > To position the Multi A Abutment more stably.

- Connect the Multi A Holder with the Multi A Abutment with its Abutment Screw in it and match the direction of holes of the abutment and the holder.
- Hold the handle of the Multi A Holder and bend it according to the placement position in the oral cavity.
- Connect the assembled body with the fixture.
- Tighten the Multi A Abutment with the Hex Driver and Torque Wrench.

Multi S Machine Driver

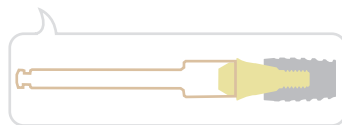

Height	Type	Machine
27.5		KMMSD21L

- > Packing unit: 1 Multi S Machine Driver.
- > To install and remove the Multi S Abutment by machine.

Multi S Ratchet Driver

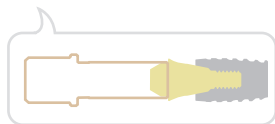
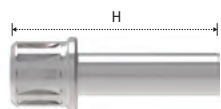

Height	Type	Ratchet
22		KRMSD15L

- > Packing unit: 1 Multi S Ratchet Driver.
- > To install and remove the Multi S Abutment with the Torque Wrench.

Prosthesis Procedure III

Component Selection Guide for Straight Abutment

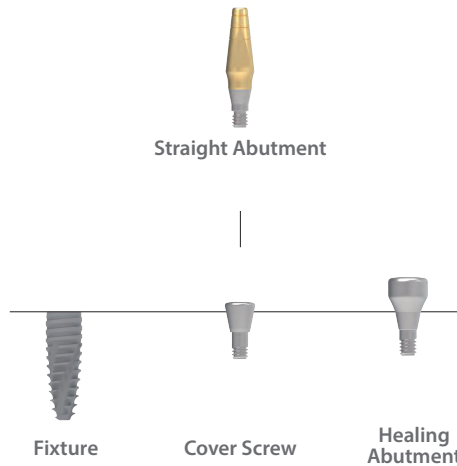

Straight Abutment

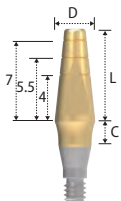

Diameter	Ø3.5				
Length [Cuff]	8 [0.5]	8 [1]	8 [2]	8 [3]	8 [4]
	SR308	SR318	SR328	SR338	SR348

- > Packing unit: 1 Straight Abutment.
- > For Cement Retained Prosthesis.
- > Integrated with screw and abutment.
- > Tightened with the Shoulder Driver.
- > Tightening torque force: 20~25N.cm.
- > Direct impression.

Shoulder Ratchet Driver

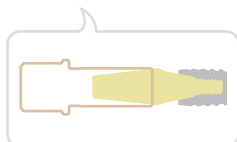





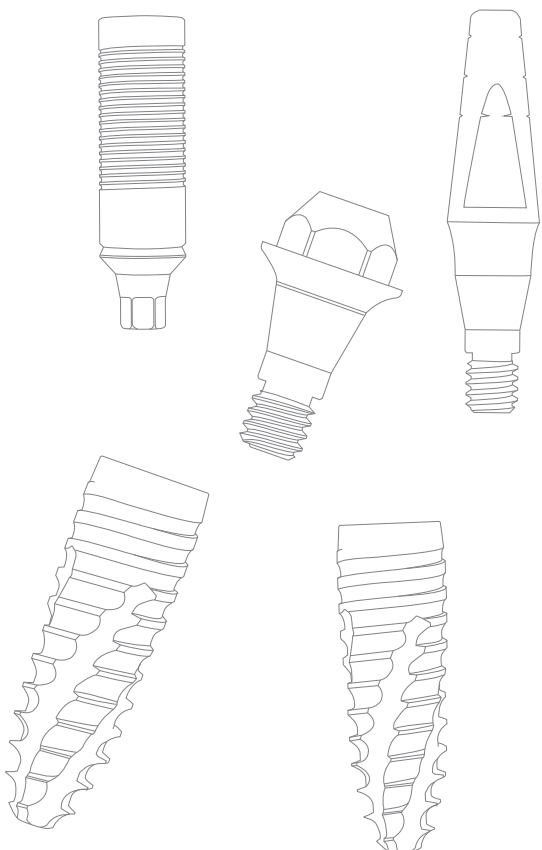

Diameter	Ø4.5
Height	19
	KRR19L



- > Packing unit: 1 Shoulder Ratchet Driver
- > To install and remove the Straight Abutment with the Torque Wrench.



INNO INTERNAL IMPLANT (Int.)

System Flow

Fixture	Abutment			
 <p>Octa 3.1</p> <p>Platform Ø4.8 / 5.9</p> <p>Cuff 1.8 / 2.4mm</p> <p>Length 7 ~ 14mm</p> <p>Diameter Ø3.5 (3.7) Ø4.0 (4.0) Ø4.5 (4.6) Ø5.0 (5.1) Ø6.0 (5.9)</p>	Prosthetic Procedure I	 Cemented Extension Abutment	 Angulated Abutment	 Meta G UCLA Abutment
	Prosthetic Procedure II	 Solid Abutment		
	Prosthetic Procedure III	 Shoulder Abutment		
	Prosthetic Procedure IV	 Ball Abutment		

	Impression
Fixture Level Impression	<div style="display: flex; justify-content: space-around; align-items: center;"> <div style="text-align: center;">  Replica </div> <div style="text-align: center;">  Pick-up Impression Coping </div> <div style="text-align: center;">  Transfer Post </div> </div>
Abutment Level Impression	<div style="display: flex; justify-content: space-around; align-items: center;"> <div style="text-align: center;">  Solid/Shoulder Protection Cap </div> <div style="text-align: center;">  Solid/Shoulder Impression Cap </div> <div style="text-align: center;">  Solid Positioning Cylinder </div> <div style="text-align: center;">  Solid Lab Analog </div> <div style="text-align: center;">  Solid Plastic Coping </div> </div>
	<div style="display: flex; justify-content: space-around; align-items: center;"> <div style="text-align: center;">  Solid/Shoulder Protection Cap </div> <div style="text-align: center;">  Solid/Shoulder Impression Cap </div> <div style="text-align: center;">  Shoulder Positioning Cylinder </div> <div style="text-align: center;">  Shoulder Lab Analog </div> </div>
	<div style="display: flex; justify-content: center; align-items: center;">  Ball Analog </div>

INNO Internal Implant (Int.)



Internal Fixture
Surface Treatment: **SLA-SH**

- > Interchangeable with 1 staged internal fixture
- > Internal Octa Connection (Taper 8°/ Octa 3.1)
- > No-Mount type

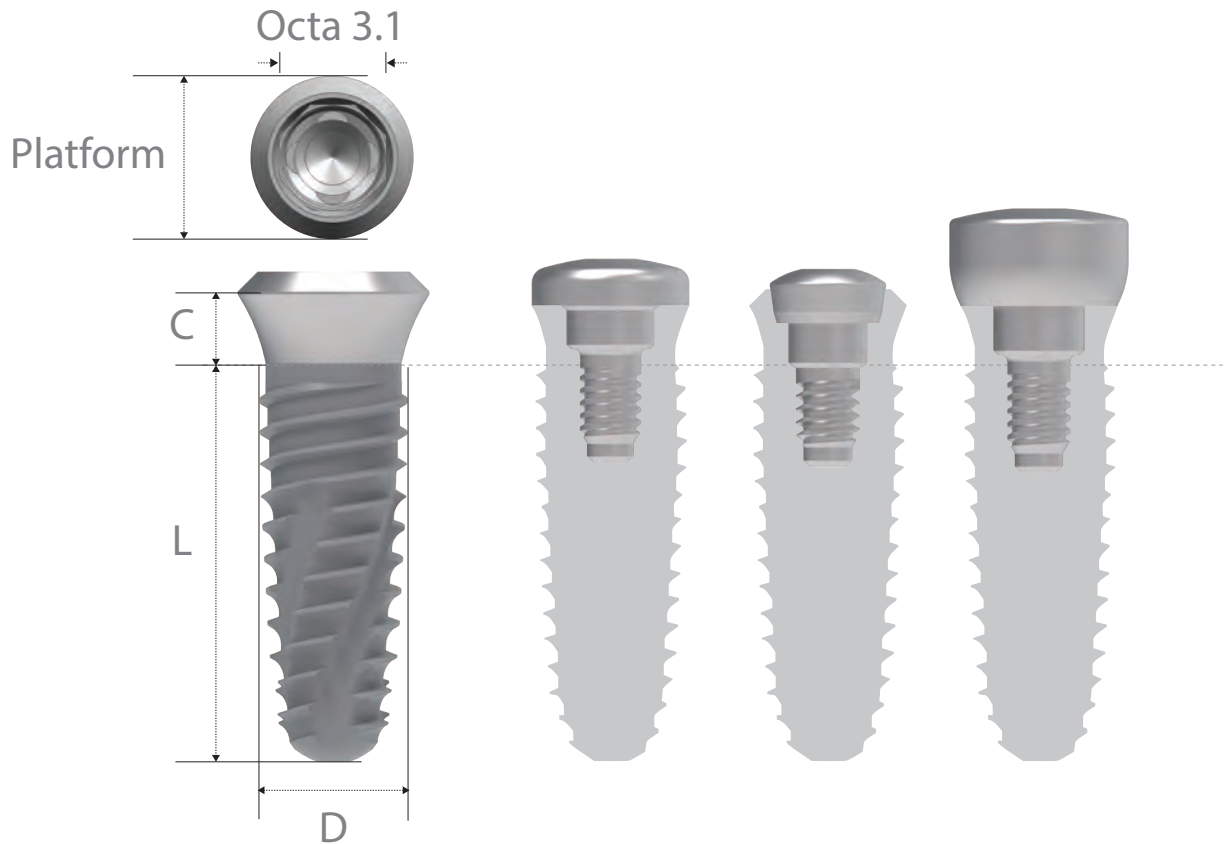

INNO Fixture Code

I	P	T	40	10	S	M	*Ex.) SLA Cuff 1.8 No-Mount	IPT4010SM
Type Internal	P=Cuff 1.8	body Taper	Diameter Ø 4.0	Length 10mm	Surface Treatment SLA	Mount No-Mount		

I		T	40	10	S	M	*Ex.) SLA Cuff 2.4 No-Mount	IT4010SM
Type Internal	Cuff 2.4	body Taper	Diameter Ø 4.0	Length 10mm	Surface Treatment SLA	Mount No-Mount		

No-Mount Cuff 1.8mm fixture > Packing unit: 1 Fixture + 1 Cover Screw.

* Diameter (Actual Size) **Ø3.5 (Ø3.7)**

Length

7	-
8	IPT3508SM
10	IPT3510SM
12	IPT3512SM
14	IPT3514SM

* Platform: Ø4.8

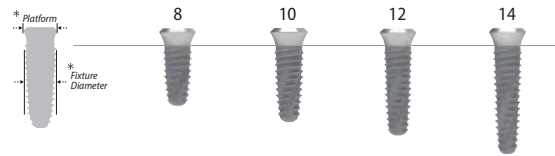

* Diameter (Actual Size) **Ø4.0 (Ø4.2)**

Length

7	IPT4007SM
8	IPT4008SM
10	IPT4010SM
12	IPT4012SM
14	IPT4014SM

* Platform: Ø4.8

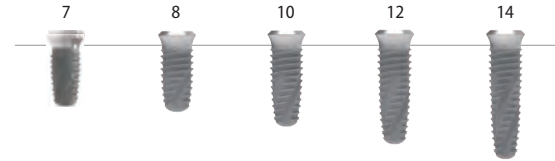

* Diameter (Actual Size) **Ø4.5 (Ø4.6)**

Length

7	IPT4507SM
8	IPT4508SM
10	IPT4510SM
12	IPT4512SM
14	IPT4514SM

* Platform: Ø4.8

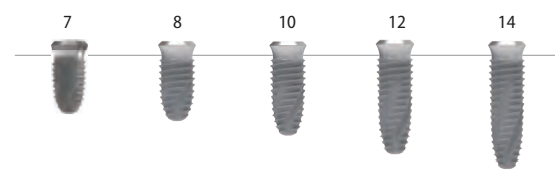

* Diameter (Actual Size) **Ø5.0 (Ø5.1)**

Length

7	IPT5007SM
8	IPT5008SM
10	IPT5010SM
12	IPT5012SM
14	IPT5014SM

* Platform: Ø5.9

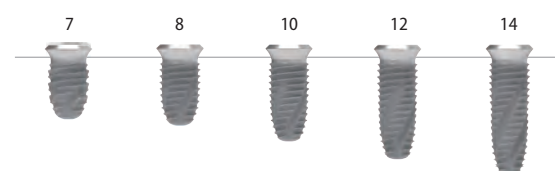

* Diameter (Actual Size) **Ø6.0 *(Ø5.9)**

Length (Actual Size)

7	*IPT6007SM
8 (7.5)	IPT6008SM
10 (9.5)	IPT6010SM
12 (11.5)	IPT6012SM
14	-

* Platform: Ø5.9

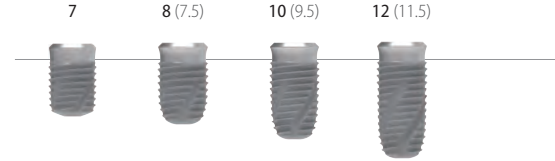

No-Mount Cuff 2.4mm fixture > Packing unit: 1 Fixture + 1 Cover Screw.

* Diameter (Actual Size) **Ø3.5 (Ø3.7)**

Length

7	-
8	IT3508SM
10	IT3510SM
12	IT3512SM
14	IT3514SM

* Platform: Ø4.8

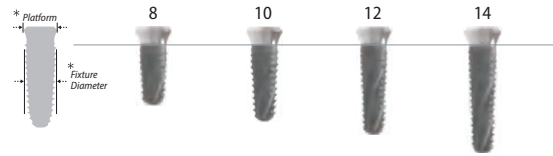

* Diameter (Actual Size) **Ø4.0 (Ø4.2)**

Length

7	IT4007SM
8	IT4008SM
10	IT4010SM
12	IT4012SM
14	IT4014SM

* Platform: Ø4.8

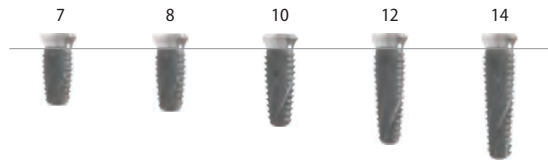

* Diameter (Actual Size) **Ø4.5 (Ø4.6)**

Length

7	IT4507SM
8	IT4508SM
10	IT4510SM
12	IT4512SM
14	IT4514SM

* Platform: Ø4.8

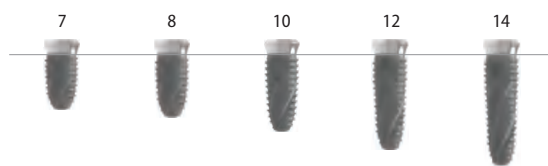

* Diameter (Actual Size) **Ø5.0 (Ø5.1)**

Length

7	IT5007SM
8	IT5008SM
10	IT5010SM
12	IT5012SM
14	IT5014SM

* Platform: Ø5.9

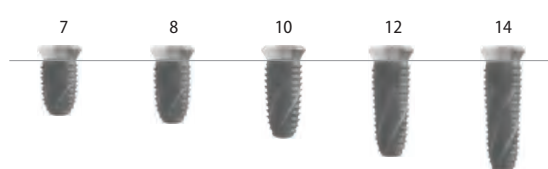

* Diameter (Actual Size) **Ø6.0 *(Ø5.9)**

Length (Actual Size)

7	*IT6007SM
8 (7.5)	IT6008SM
10 (9.5)	IT6010SM
12 (11.5)	IT6012SM
14	-

* Platform: Ø5.9

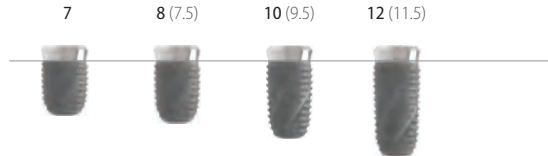

Cover Screw

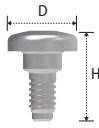

Platform [Fixture Dia.]	Ø4.8 [Ø3.5 / Ø4.0 / Ø4.5]	Ø5.9 [Ø5.0 / Ø6.0]
Diameter	Ø5.0	Ø6.0
Height	6.5	ICVR002
		ICVW002

- > Packing unit: 1 Cover Screw.
- > To seal the conical interface of the fixture.
- > Tightened with the Hex Driver.
- > Tightening torque force: 5~10N.cm.

Headless Screw



Diameter	Ø3.5
Height	6
	ICVR001

- > Packing unit: 1 Headless Screw.
- > For narrow mesiodistal distance.
- > Tightened with the Hex Driver.
- > Tightening torque force: 5~10N.cm.

Healing Abutment

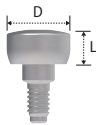

Platform [Fixture Dia.]	Ø4.8 [Ø3.5 / Ø4.0 / Ø4.5]	Ø5.9 [Ø5.0 / Ø6.0]
Diameter	Ø5.5	Ø6.6
Length	2	IHCR020
		IHCW020
	3	IHCR030
		IHCW030
	4.5	IHCR045
		IHCW045

- > Packing unit: 1 Healing Abutment.
- > For remodeling gingival contour during soft tissue healing.
- > Select the abutment according to gingival height and abutment type.
- > Tightened with the Hex Driver.
- > Tightening torque force: 5~10N.cm.

Prosthetic Procedure I

Component Selection Guide for Cemented & UCLA Abutment

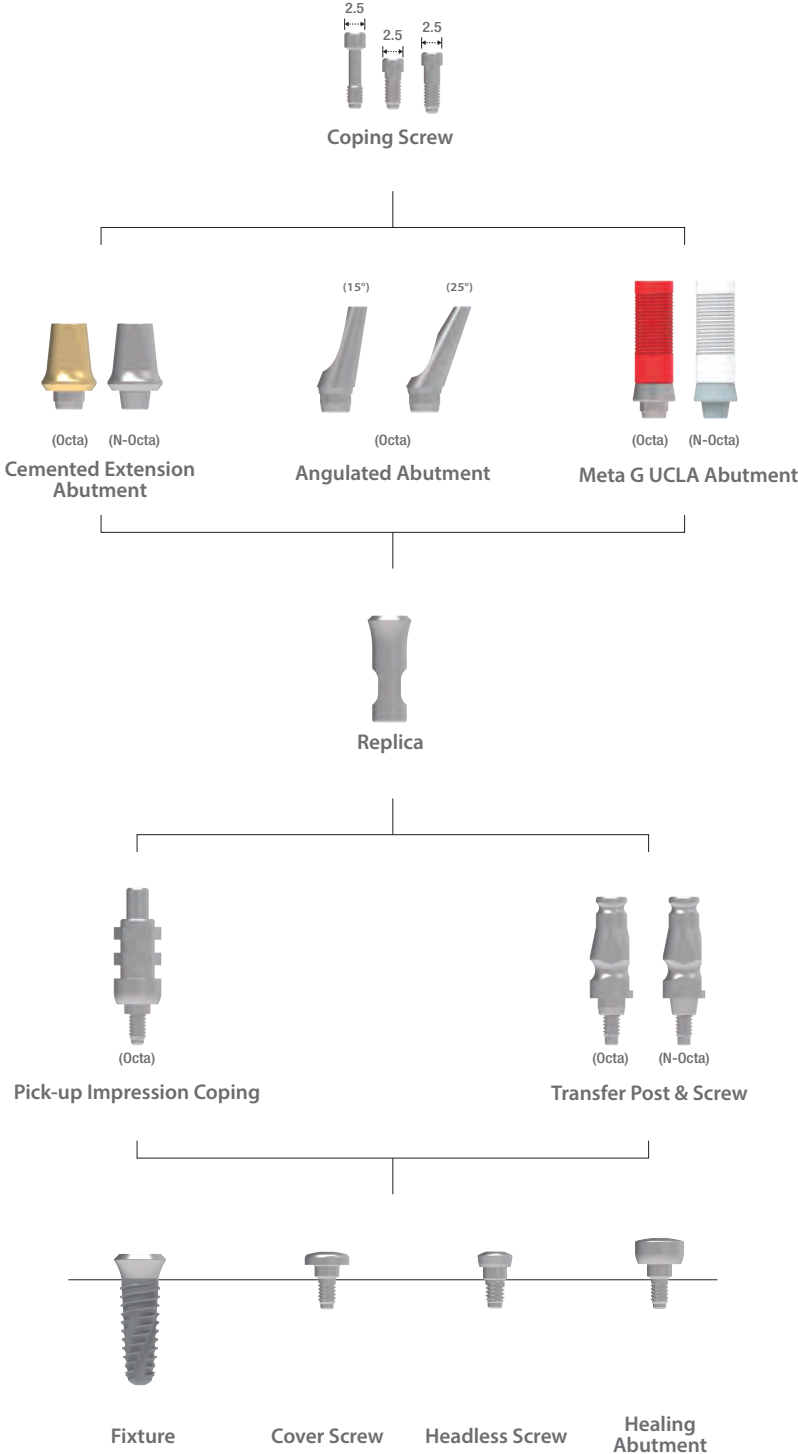

Cemented Extension Abutment

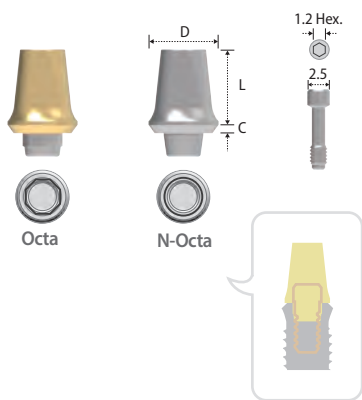

Type	Octa			
Platform [Fixture Dia.]	Ø4.8 [Ø3.5 / Ø4.0 / Ø4.5]		Ø5.9 [Ø5.0 / Ø6.0]	
Diameter	Ø4.8	Ø5.8	Ø5.9	Ø6.9
Cuff Length	6	6	6	6
0.5	IECR406		IECW506	
1		IECR416		IECW516
2		IECR426		IECW526
3		IECR436		IECW536
Type	N-Octa			
Platform [Fixture Dia.]	Ø4.8 [Ø3.5 / Ø4.0 / Ø4.5]		Ø5.9 [Ø5.0 / Ø6.0]	
Diameter	Ø4.8	Ø5.8	Ø5.9	Ø6.9
Cuff Length	6	6	6	6
0.5	IENR406		IENW506	
1		IENR416		IENW516
2		IENR426		IENW526
3		IENR436		IENW536

- > Packing unit: 1 Cemented Extension Abutment + 1 Abutment Screw.
- > For Cement Retained or Screw-Cement Retained Prosthesis.
- > Cutting surface for anti-rotation of the prosthesis.
- > Connected with the Abutment Screw (ISHR110).
- > Tightened with the Hex Driver and Torque Wrench.
- > Tightening torque force: 30N.cm.
- > Fixture level impression.

Angulated Abutment

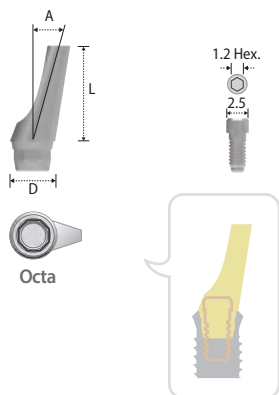

Type	Octa	
Platform [Fixture Dia.]	Ø4.8 & Ø5.9 [Ø3.5 / Ø4.0 / Ø4.5 / Ø5.0 / Ø6.0]	
Diameter (Angle)	3.8 (15°)	3.8 (25°)
Length		
8	IAAR158A	IAAR258A

- > Packing unit: 1 Angulated Abutment + 1 Abutment Screw.
- > For Cement Retained or Screw-Cement Retained Prosthesis.
- > Solution for the anterior esthetic zone.
- > Connected with the Abutment Screw (ISHR100).
- > Tightened with the Hex Driver and Torque Wrench.
- > Tightening torque force: 30N.cm.
- > Fixture level impression.

Meta G UCLA Abutment

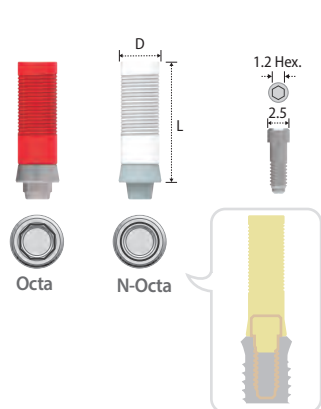

Type	Octa		N-Octa	
Platform [Fixture Dia.]	Ø4.8 [Ø3.5 / Ø4.0 / Ø4.5]	Ø5.9 [Ø5.0 / Ø6.0]	Ø4.8 [Ø3.5 / Ø4.0 / Ø4.5]	Ø5.9 [Ø5.0 / Ø6.0]
Diameter	Ø5	Ø6	Ø5	Ø6
Length				
12	IGOR400N	IGOW500N	IGNR400N	IGNW500N

- > Packing unit: 1 Meta G UCLA Abutment + 1 Abutment Screw.
- > For Screw-Cement or Screw Retained Prosthesis.
- > Modification to the angulated abutment, customized abutment and telescopic abutment.
- > CCM alloy core for precise connection.
- > Cast with non-precious metal or gold alloy.
- > Connected with the Abutment Screw (ISHR120).
- > Tightened with the Hex Driver and Torque Wrench.
- > Tightening torque force: 30N.cm.
- > Fixture level impression.

Abutment Screw

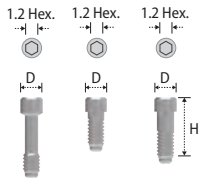

Diameter	Ø2.5	Ø2.5	Ø2.5
Height	6.3	ISHR100	
	7.8		ISHR120
	9.2	ISHR110	

- > Packing unit: 1 Abutment Screw.
- > ISHR110: Cemented Abutment.
- > ISHR100: Angulated Abutment.
- > ISHR120: Meta G UCLA Abutment.
- > Tightened with the Hex Driver and Torque Wrench.

Replica



Platform [Fixture Dia.]	Ø4.8 [Ø3.5 / Ø4.0 / Ø4.5]	Ø5.9 [Ø5.0 / Ø6.0]
Diameter	Ø4.8	
Height	Ø5.9	
	IROR001	IROW001

- > Packing unit: 1 Replica.
- > Mimicking of the conical interface of the fixture.
- > Analog of fixture for the working cast.

Pick-up Impression Coping

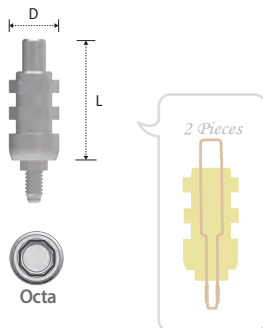

Type	Octa	
Platform [Fixture Dia.]	Ø4.8 [Ø3.5 / Ø4.0 / Ø4.5]	Ø5.9 [Ø5.0 / Ø6.0]
Diameter	Ø5.5	
Length	Ø6.6	
	IIOR001	IIOW001

- > Packing unit: 1 Pick-up Impression Coping + 1 Guide Pin.
- > For open tray impression.
- > Connected with the Guide Pin (IIOR001S).
- > Tightened with the Hex Driver and Torque Wrench.
- > Tightening torque force: 12~15N.cm.

Transfer Post

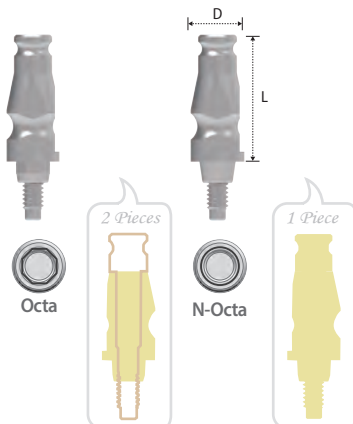

Type	Octa		N-Octa	
Platform [Fixture Dia.]	Ø4.8 [Ø3.5 / Ø4.0 / Ø4.5]	Ø5.9 [Ø5.0 / Ø6.0]	Ø4.8 [Ø3.5 / Ø4.0 / Ø4.5]	Ø5.9 [Ø5.0 / Ø6.0]
Diameter	Ø4.85		Ø4.85	
Length	Ø5.95		Ø5.95	
	ITOR400	ITOW500	ITNR400	ITNW500

- > Packing unit: Octa - 1 Transfer Post + 1 Guide Pin / N-Octa - 1 Transfer Post (Solid Type).
- > For closed tray impression.
- > Connected with the Guide Pin (Regular: ITOR400S / Wide: ITOW500S).
- > Tightened with the Hex Driver and Torque Wrench.
- > Tightening torque force: 12~15N.cm.

Prosthetic Procedure II

Component Selection Guide for Solid Abutment

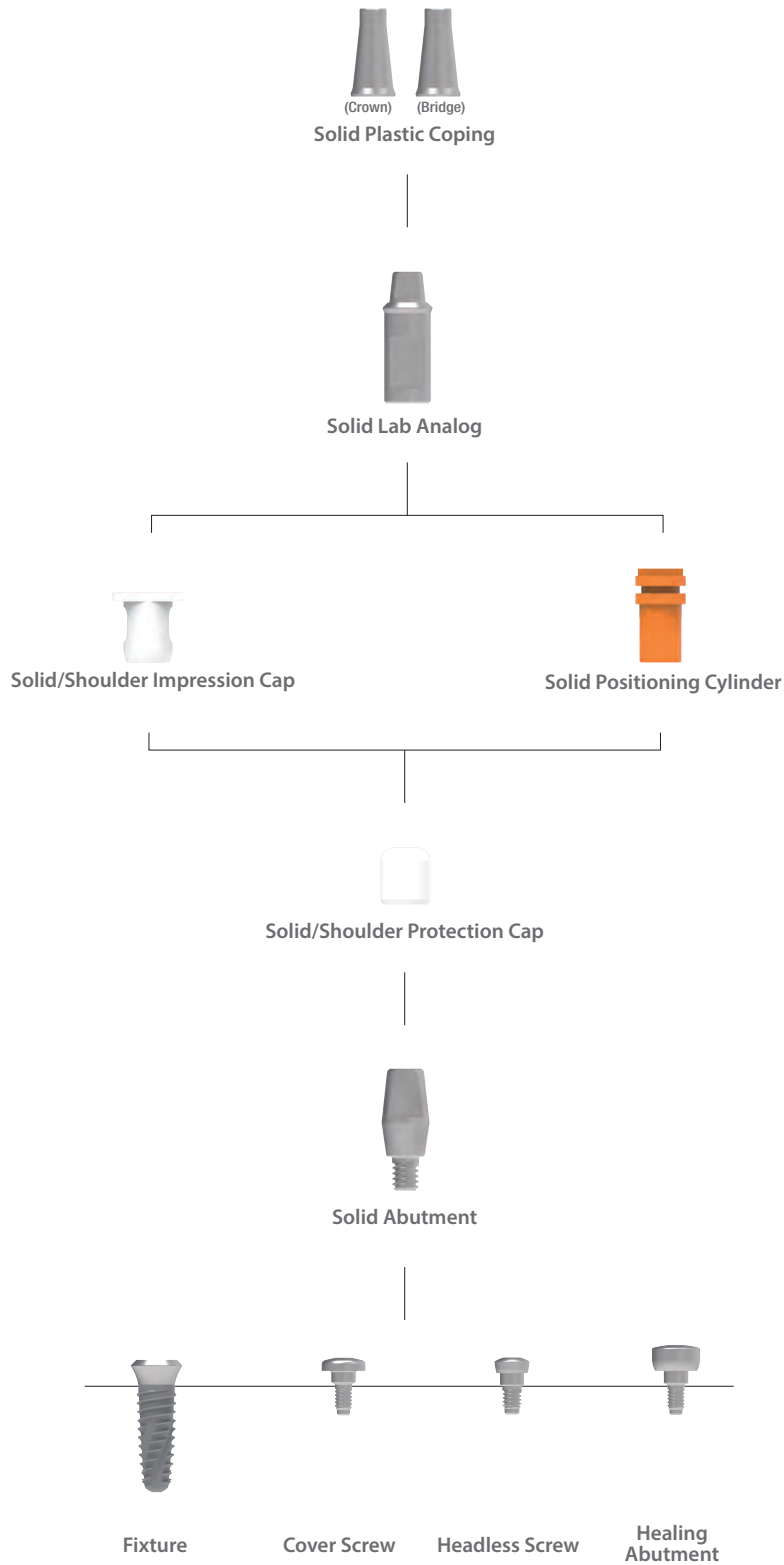

Solid Abutment



Platform [Fixture Dia.]	Ø4.8 & Ø5.9 [Ø3.5 / Ø4.0 / Ø4.5 / Ø5.0 / Ø6.0]			
Diameter	Ø3.5			
Length	3	4	5.5	7
	IASR030	IASR040	IASR055	IASR070

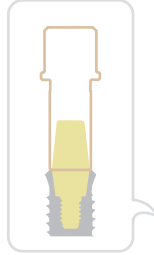

- > Packing unit: 1 Solid Abutment + 1 Protection Cap.
- > For Cement Retained Prosthesis.
- > Cutting surface for anti-rotation of the prosthesis.
- > Integrated with screw and abutment.
- > Tightened with the Shoulder Ratchet Driver.
- > Tightening torque force: 30N.cm.
- > Abutment level impression:
Impression cap in platform Ø4.1 fixture and direct impression in platform Ø5.8 fixture.



Shoulder Ø4.5 KRR19L

Solid/Shoulder Protection Cap

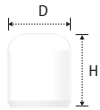

Solid Abutment Diameter	Ø3.5
Diameter / Height	Ø5.4
5.2	IASR130
6.2	IASR140
7.7	IASR155
9.2	IASR170

- > Packing unit: 1 Solid/Shoulder Protection Cap.
- > Protection from cheek and tongue for gingival healing period.
- > Alternative usage for sub-structure of the temporary prosthesis.

Solid/Shoulder Impression Cap



Solid Abutment Diameter	Ø3.5
Diameter / Height	8
8	IICR001

- > Packing unit: 1 Solid/Shoulder Impression Cap.
- > Connected with the Solid Positioning Cylinder.
- > Confirm locking with abutment by rotation of clockwise and anti-clockwise direction.

Solid Positioning Cylinder



Solid Abutment Diameter	Ø3.5	
Diameter	Ø5.7	
Height	10.2	IPCR001

- > Packing unit: 1 Solid Positioning Cylinder.
- > Inner cutting surface for anti-rotation on the abutment.
- > Insert into the Impression Cap.

Solid Lab Analog



Solid Abutment Diameter	Ø3.5			
Diameter	Ø4.8			
Length	3	4	5.5	7
	ILSR030	ILSR040	ILSR055	ILSR070

- > Packing unit: 1 Solid Lab Analog.
- > Replacement of abutment shape in working cast.
- > Choose according to length of the abutment.

Solid Plastic Coping

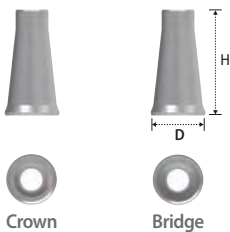

Type	Crown	Bridge
Solid Abutment Diameter	Ø3.5	Ø3.5
Diameter	Ø5.0	Ø5.0
Height	10	IPCB001

- > Packing unit: 1 Solid Plastic Coping.
- > Connect with the Lab Analog.
- > Burn out and casting for the metal framework.

Prosthetic Procedure III

Component Selection Guide for Shoulder Abutment

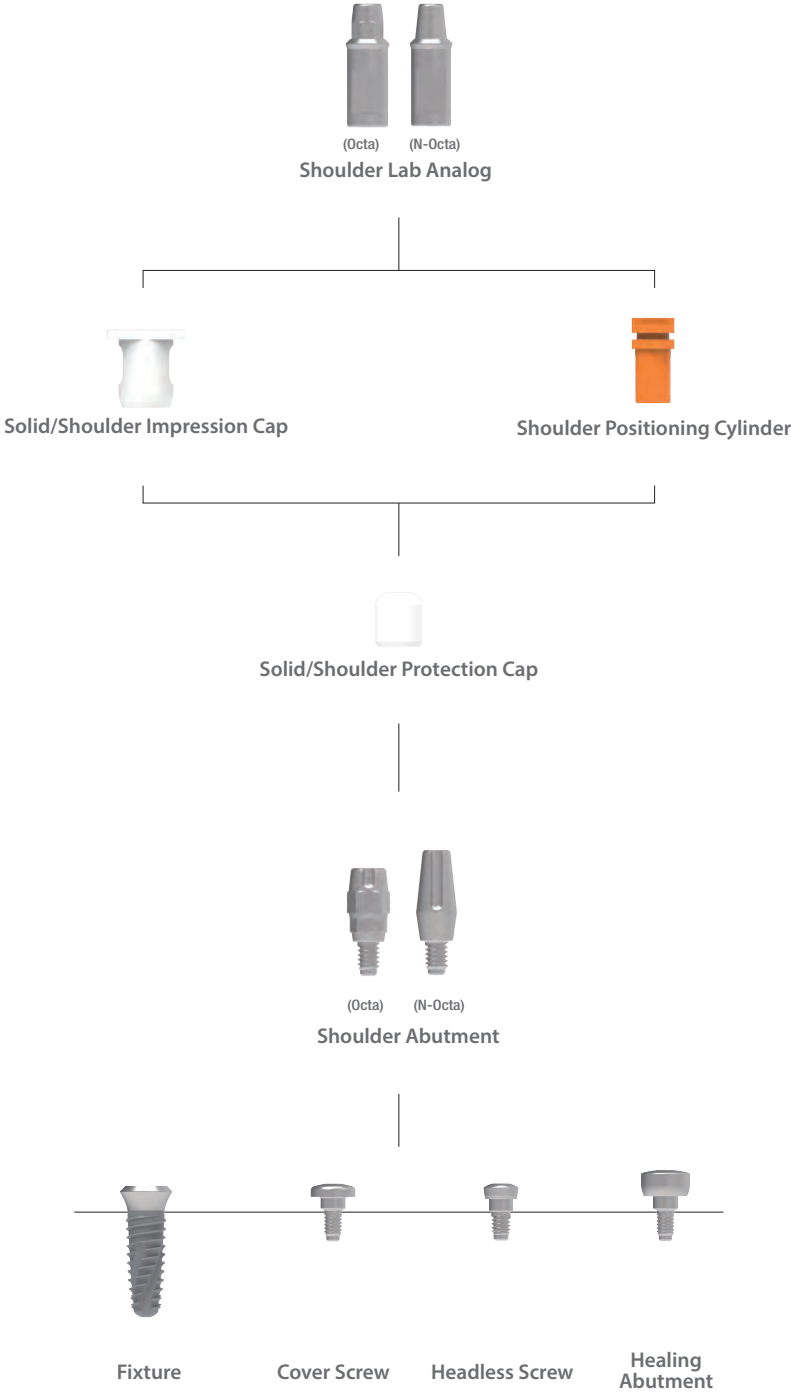

Shoulder Abutment

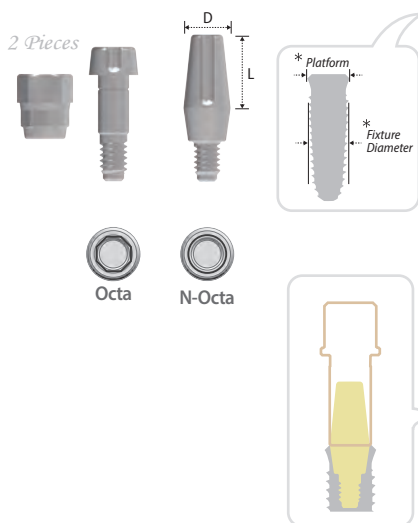

Type	Octa		N-Octa	
* Platform [Fixture Dia.]	Ø4.8 [Ø3.5 / Ø4.0 / Ø4.5]	Ø5.9 [Ø5.0 / Ø6.0]	Ø4.8 [Ø3.5 / Ø4.0 / Ø4.5]	Ø5.9 [Ø5.0 / Ø6.0]
Diameter	Ø3.5	Ø4.5	Ø3.5	Ø4.5
Length	4	5.5	7	
	ISAC404	ISAC504	ISAB404	ISAB504
	ISAC405	ISAC505	ISAB405	ISAB505
	ISAC407	ISAC507	ISAB407	ISAB507

- > Packing unit: 1 Shoulder Abutment + 1 Protection Cap.
- > For Cement Retained Prosthesis.
- > Dual anti-rotation grip with a single crown for prevention of screw loosening.
- > Integrated with the Screw and Abutment.
- > Tightened with the Shoulder Ratchet Driver.
- > Tightening torque force: 30N.cm.
- > Abutment level impression.



Solid/Shoulder Protection Cap



Shoulder Abutment Diameter	Ø3.5	Ø4.5
Diameter	Ø5.4	Ø5.4
Height	6.2	7.7
	IASR140	IASW140
	IASR155	IASW155
	IASR170	IASW170

- > Packing unit: 1 Solid/Shoulder Protection Cap.
- > Protection from cheek and tongue for gingival healing period.
- > Alternative usage for sub-structure of the temporary prosthesis.

Solid/Shoulder Impression Cap

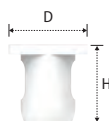

Shoulder Abutment Diameter	Ø3.5	Ø4.5
Diameter	8	9
Height	8	10.7
	IICR001	IICW001

- > Packing unit: 1 Solid/Shoulder Impression Cap.
- > Connected with the Shoulder Positioning Cylinder.
- > Confirm locking with abutment by rotation of clockwise and anti-clockwise direction.

Shoulder Positioning Cylinder

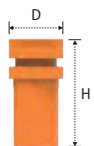

Shoulder Abutment Diameter	Ø3.5	Ø4.5
Diameter	5.7	6.8
Height	10.7	12.2
	SAPR001	SAPW001

- > Packing unit: 1 Shoulder Positioning Cylinder.
- > Inner cutting surface for anti-rotation on the abutment.
- > Insert into the Impression Cap.

Shoulder Lab Analog

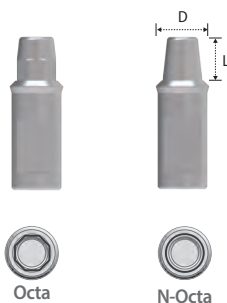

Type	Octa		N-Octa	
Shoulder Abutment Diameter	Ø3.5	Ø4.5	Ø3.5	Ø4.5
Diameter	Ø4.8	Ø5.9	Ø4.8	Ø5.9
Length	4	5.5	7	
	SLCR040	SLCW040	SLBR040	SLBW040
	SLCR055	SLCW055	SLBR055	SLBW055
	SLCR070	SLCW070	SLBR070	SLBW070

- > Packing unit: 1 Shoulder Lab Analog.
- > Replacement of abutment shape in working cast.
- > Choose according to width and length of the abutment.

Prosthetic Procedure IV

Component Selection Guide for Sonator S&A Abutment

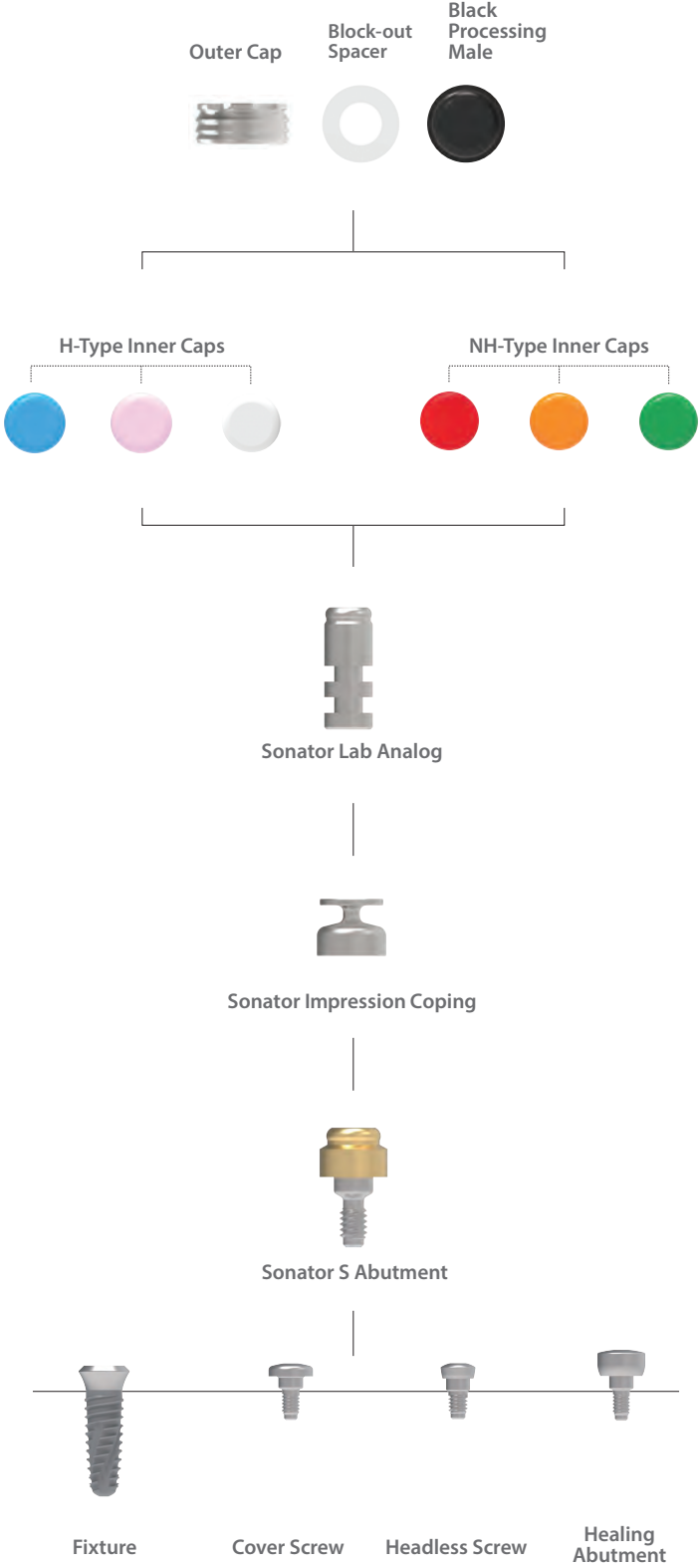

Sonator S Abutment

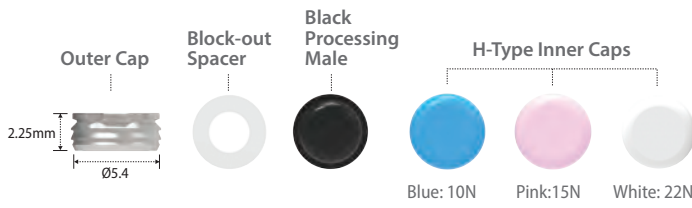

Diameter	Ø4.0				
Cuff Length	0.6	2	3	4	
	1.5	IONS401	IONS402	IONS403	IONS404

- > Packing unit: 1 Sonator S Abutment + 1 Carrier + 3 H-Type Inner Caps + 1 Outer Cap + 1 Block-out Spacer + 1 Black Processing Male.
- > For Implant-Supported Overdenture Prosthesis.
- > Stable with low vertical height.
- > 6 kinds of Inner Caps give various holding force (Both, H and NH-Type Inner Caps are used for the Sonator S Abutment).
- > Path compensation up to 20° based on 2 implants.
- > Carrier: Used for delivery of the abutment.
- > Tightened with the Ratchet Driver and Torque wrench.
- > Tightening torque force: 30N.cm.
- > Abutment level impression.

Outer Cap

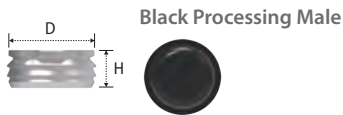

Diameter	Ø5.4
Height	SONOC01
	2.25

- > Packing unit: 2 Outer Caps and 2 Black Processing Males.
- > Black Processing Male: Inserted and Removed with the I&R Driver.

H-Type Inner Cap

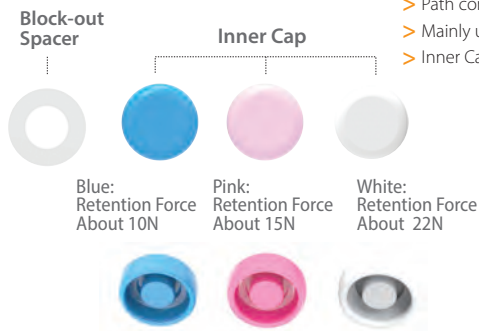

Code	SONIC01
------	---------

- > Packing unit: 3 Block-out Spacers + 3 Inner Caps (1 Blue, 1 Pink, and 1 White).
- > Path compensation up to 20° based on 2 implants.
- > Mainly used for the Sonator S Abutment.
- > Inner Caps: Inserted and Removed with the I&R Driver.

NH-Type Inner Cap

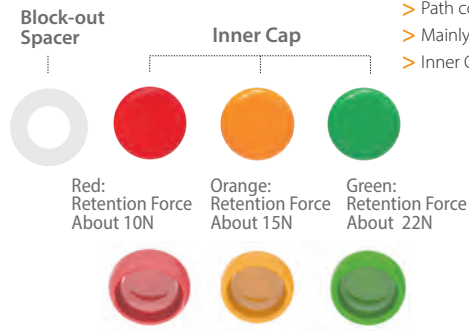

<i>Code</i>	SONIC02
-------------	---------

- > Packing unit: 3 Block-out Spacers + 3 Inner Caps (1 Red, 1 Orange, and 1 Green).
- > Path compensation up to 40° based on 2 implants.
- > Mainly used for the Sonator A Abutment.
- > Inner Caps: Inserted and Removed with the I&R Driver.

Sonator Impression Coping

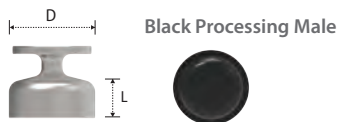

<i>Diameter</i>	Ø4.8
<i>Length</i>	3
	SONIP04

- > Packing unit: 4 Impression Copings and 4 Black Processing Males.
- > Abutment level pick-up impression.
- > Connected over the Sonator Abutment after placing the Block-out Spacer.
- > For close tray impression.

Sonator Lab Analog



<i>Diameter</i>	Ø4
<i>Length</i>	1.4
	SONLA04

- > Packing unit: 4 Sonator Lab Analogs.
- > Replacement of abutment shape in working cast.

Sonator S Ratchet Driver

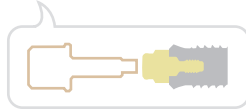
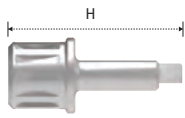

Type	Ratchet
Height	SONRD19L

- > Packing unit: 1 Sonator S Ratchet Driver.
- > To install and remove the Sonator S Abutment with the Torque Wrench.

Sonator I&R Driver

Height	95.4
	SONIR002

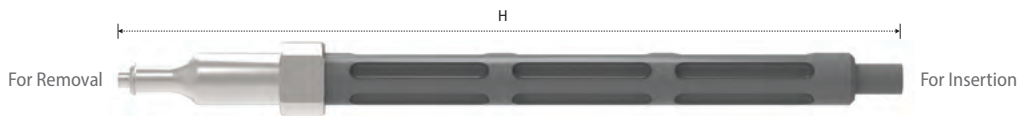

- > Packing unit: 1 Sonator I&R Driver.
- > Used to insert and remove the Inner Caps and Block Processing Male.

Prosthetic Procedure V

Component Selection Guide for Ball Abutment

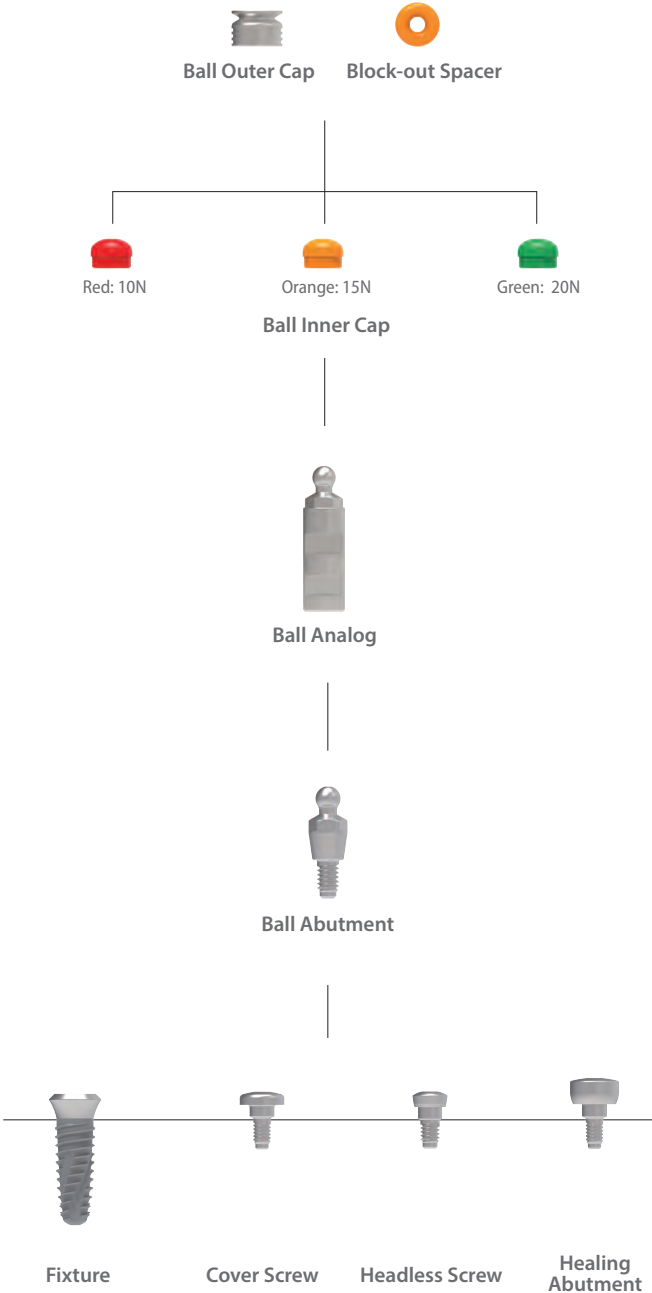

Ball Abutment

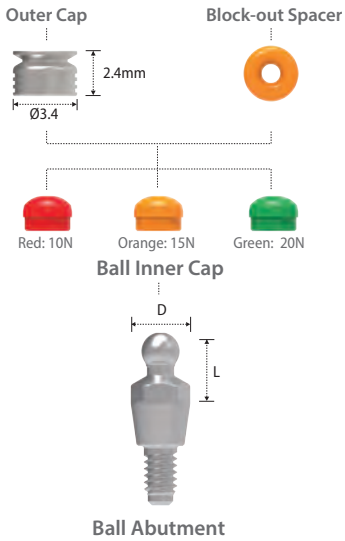

<i>Diameter</i>	Ø3.5
<i>Length</i>	4
IBAT404R	

- > Packing unit: 1 Ball Abutment + 3 Inner Caps (1 per each color) + 1 Block-out Spacer + 1 Outer Cap.
- > For Implant-Supported Overdenture Prosthesis.
- > Tightened with the Ball Ratchet Driver and Torque Wrench.
- > Tightening torque force: 30N.cm.
- > Direct impression.

Ball Outer Cap

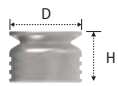

<i>Diameter</i>	Ø3.4
<i>Height</i>	2.4
BATC003C	

- > Packing unit: 2 Outer Caps.

Ball Inner Cap

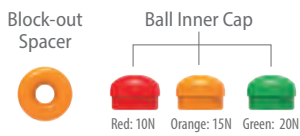

BATC003I	
----------	--

- > Packing unit: 2 Block-out Spacers + 6 Inner Caps (2 per each color).
- > Retention force: Red 10N, Orange 15N & Green 20N.

Ball Lab Analog



<i>Diameter</i>	Ø4.0
<i>Length</i>	4
SBAL400	

- > Packing unit: 4 Ball Lab Analogs.
- > Replacement of abutment shape in working cast.

Ball Ratchet Driver

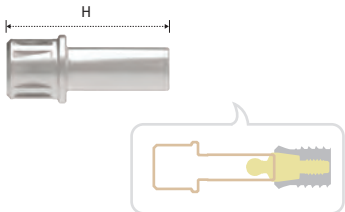

<i>Type</i>	Ratchet
<i>Height</i>	19
KRB19L	

- > Packing unit: 1 Ball Ratchet Driver. *Extra Product
- > To install and remove the Ball Abutment with the Torque Wrench.

Ball I&R Driver

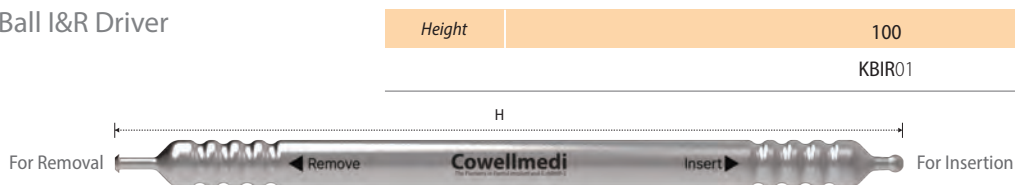







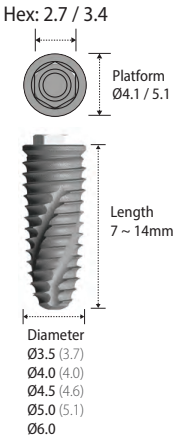

<i>Height</i>	100
KBIR01	

- > Packing unit: 1 Ball I&R Driver.
- > Used to insert and remove the Inner Caps into and out of the Outer Cap.

INNO EXTERNAL IMPLANT (Ext.)

System Flow

Fixture	Abutment	
 <p>Hex: 2.7 / 3.4</p> <p>Platform Ø4.1 / 5.1</p> <p>Length 7 ~ 14mm</p> <p>Diameter Ø3.5 (3.7) Ø4.0 (4.0) Ø4.5 (4.6) Ø5.0 (5.1) Ø6.0</p>	Prosthetic Procedure I	<div style="display: flex; justify-content: space-around; align-items: center;"> <div style="text-align: center;">  Cemented Abutment </div> <div style="text-align: center;">  Angulated Abutment </div> </div> <div style="display: flex; justify-content: space-around; align-items: center; margin-top: 20px;"> <div style="text-align: center;">  Temporary Abutment </div> <div style="text-align: center;">  Meta G UCLA Abutment </div> <div style="text-align: center;">  Plastic UCLA Abutment </div> </div>
	Prosthetic Procedure II	 Shoulder Abutment
	Prosthetic Procedure III	 Ball Abutment

	Impression			
Fixture Level Impression	 Replica	 Pick-up Squared Impression Coping	 Transfer Post	
Abutment Level Impression	 Solid/Shoulder Protection Cap	 Solid/Shoulder Impression Cap	 Shoulder Positioning Cylinder	 Shoulder Lab Analog
	 Ball Analog			

INNO External Implant (Ext.)



External Fixture
Surface Treatment: **SLA-SH**

- > Interchangeable with external hexagonal fixture.
- > External hex connection (Hex 2.7 / 3.4).

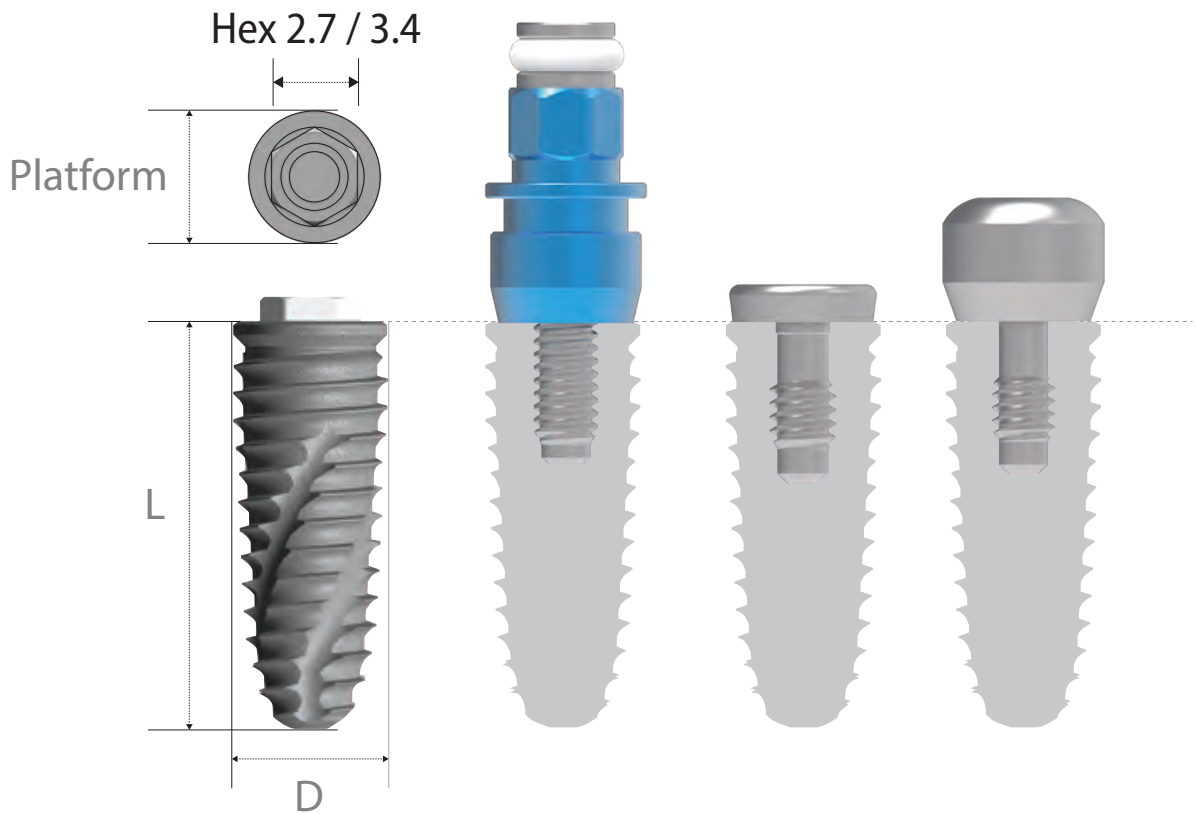

INNO Fixture Code

E	T	40	10	S	<input type="checkbox"/>
Type External	body Taper	Diameter Ø 4.0	Length 10 mm	Surface Treatment SLA	Mount Pre-Mount

*Ex.)
SLA Pre-Mount **ET4010S**

Pre-Mount

> Packing unit: 1 Fixture + 1 Mount + 1 Mount Screw.

* Diameter (Actual Size) **Ø3.5 (Ø3.7)**

Length

7	-
8	ET3508S
10	ET3510S
12	ET3512S
14	ET3514S

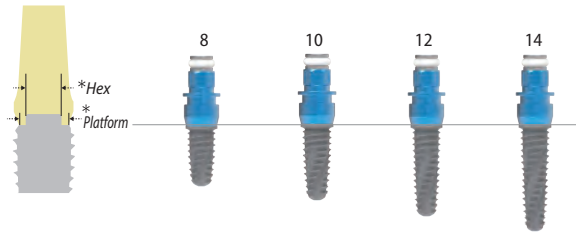

* Diameter (Actual Size) **Ø4.0 (Ø4.2)**

Length

7	ET4007S
8	ET4008S
10	ET4010S
12	ET4012S
14	ET4014S

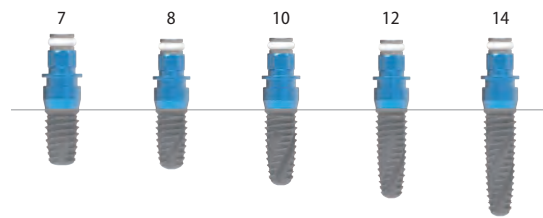

* Diameter (Actual Size) **Ø4.5 (Ø4.6)**

Length

7	ET4507S
8	ET4508S
10	ET4510S
12	ET4512S
14	ET4514S

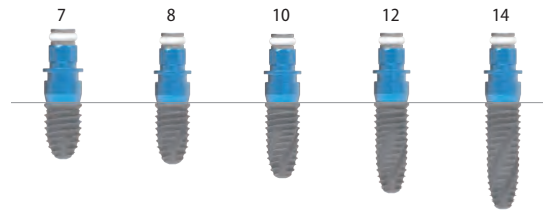

* Diameter (Actual Size) **Ø5.0 (Ø5.1)**

Length

7	ET5007S
8	ET5008S
10	ET5010S
12	ET5012S
14	ET5014S

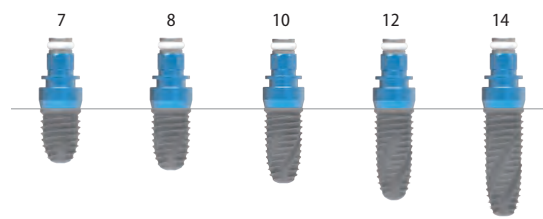

* Diameter (Actual Size) **Ø6.0**

Length (Actual Size)

7	ET6007S
8 (7.5)	ET6008S
10 (9.5)	ET6010S
12 (11.5)	ET6012S
14	-

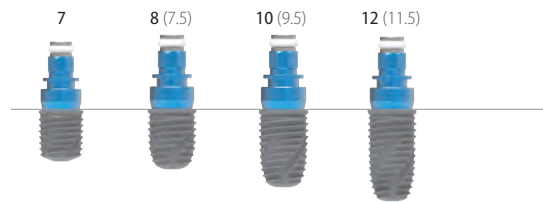

Fixture Mount

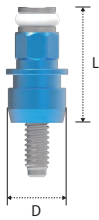

Hex	Hex2.7	Hex3.4
Platform [Fixture Dia.]	Ø4.1 [Ø3.5 / Ø4.0 / Ø4.5]	Ø5.1 [Ø5.0 / Ø6.0]
Diameter	Ø4.6	Ø5.5
Length	7.2	7.2
	MER001	MEW002

- > Packing unit: 1 Mount + 1 Mount Screw.
- > Tightened with the Hex Driver.
- > Tightening torque force: 5~10N.cm.

Cover Screw

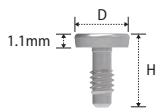

Hex	Hex2.7	Hex3.4
Platform [Fixture Dia.]	Ø4.1 [Ø3.5 / Ø4.0 / Ø4.5]	Ø5.1 [Ø5.0 / Ø6.0]
Diameter	Ø4.3	Ø5.4
Height	5.8	5.8
	VNR001	VNW001

- > Packing unit: 1 Cover Screw.
- > To seal the conical interface of the fixture.
- > Tightened with the Hex Driver.
- > Tightening torque force: 5~10N.cm.

Healing Abutment

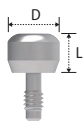

Hex	Hex2.7	Hex3.4
Platform [Fixture Dia.]	Ø4.1 [Ø3.5 / Ø4.0 / Ø4.5]	Ø5.1 [Ø5.0 / Ø6.0]
Diameter	Ø5.0	Ø6.0
Length	2.8	2.8
	HNR502	HNW602
	3.8	3.8
	HNR503	HNW603
	4.8	4.8
	HNR504	HNW604
	5.8	5.8
	HNR505	HNW605
	6.8	6.8
	HNR506	HNW606
	7.8	7.8
	HNR507	HNW607

- > Packing unit: 1 Healing Abutment.
- > For remodeling gingival contour during soft tissue healing.
- > Select the abutment according to gingival height and abutment type.
- > Tightened with the Hex Driver.
- > Tightening torque force: 5~10N.cm.

Prosthetic Procedure I

Component Selection Guide for Cemented & UCLA Abutment

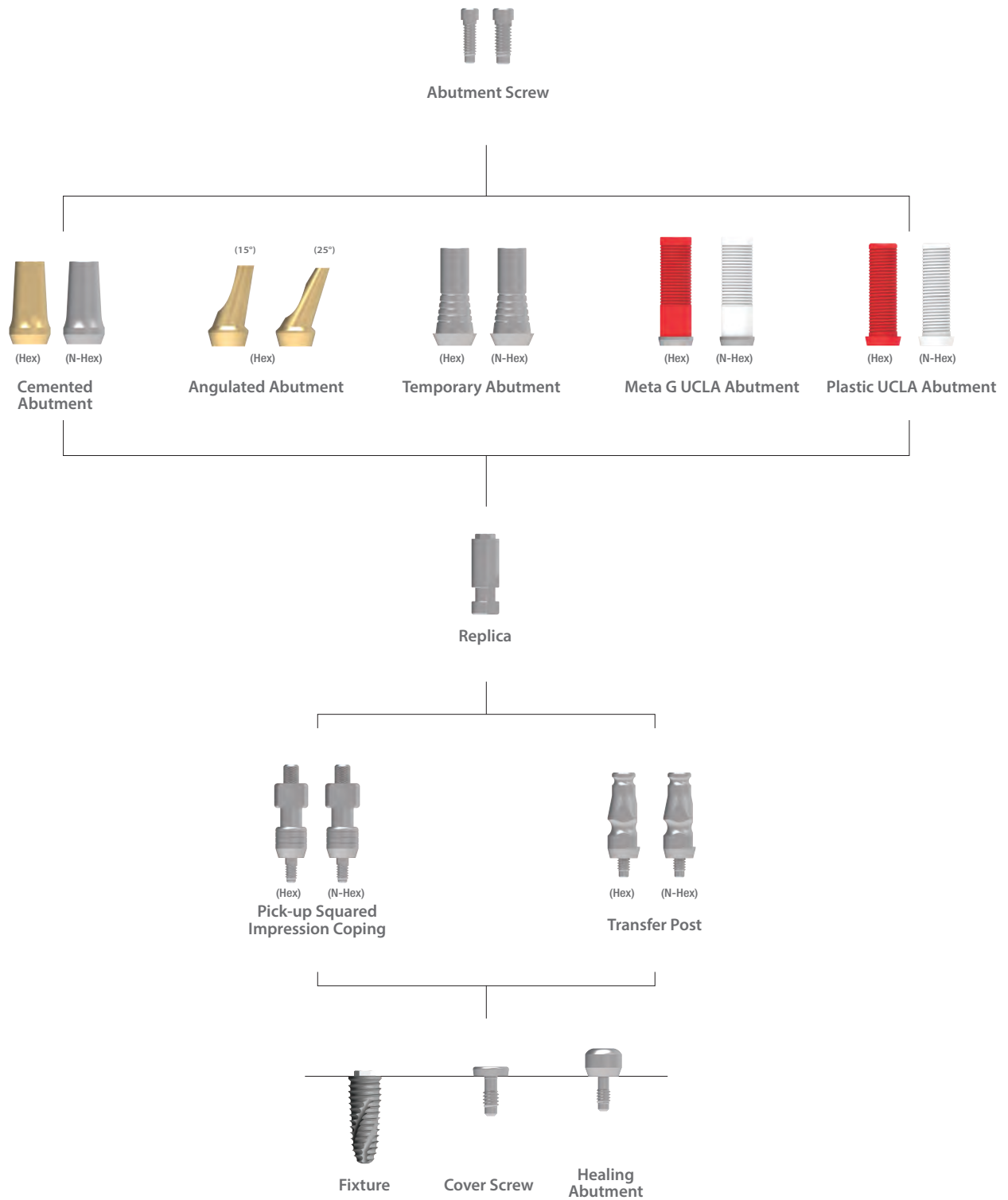

Cemented Abutment

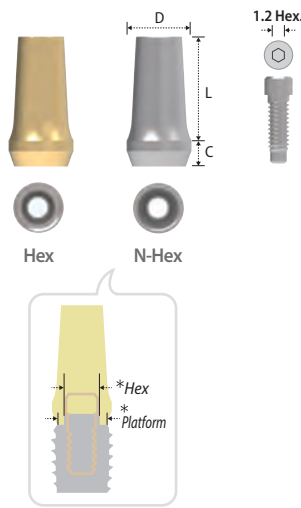

* Type[Hex]	Hex[2.7]		Hex[3.4]	
* Platform [Fixture Dia.]	Ø4.1 [Ø3.5 / Ø4.0 / Ø4.5]		Ø5.1 [Ø5.0 / Ø6.0]	
Diameter	Ø5.0		Ø6.0	
Length / Cuff	6	8	6	8
1	CHR516	CHR518	CHW616	CHW618
2	CHR526	CHR528	CHW626	CHW628
3	CHR536	CHR538	CHW636	CHW638
4	CHR546	CHR548	CHW646	CHW648

Type[Hex]	N-Hex			
Platform [Fixture Dia.]	Ø4.1 [Ø3.5 / Ø4.0 / Ø4.5]		Ø5.1 [Ø5.0 / Ø6.0]	
Diameter	Ø5.0		Ø6.0	
Length / Cuff	6	8	6	8
1	CNR516	CNR518	CNW616	CNW618
2	CNR526	CNR528	CNW626	CNW628
3	CNR536	CNR538	CNW636	CNW638
4	CNR546	CNR548	CNW646	CNW648

- > Packing unit: 1 Cemented Abutment + 1 Abutment Screw.
- > For Cement Retained and Screw-Cement Retained Prosthesis.
- > Cutting surface for anti-rotation of the prosthesis.
- > Connected with the Abutment Screw.
- > Tightened with the Hex Driver and Torque Wrench.
- > Tightening torque force: 30N.cm
- > Fixture level impression.

Angulated Abutment

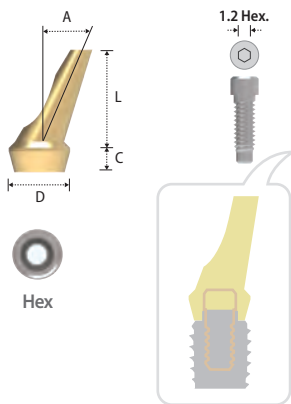

Type[Hex]	Hex[2.7]	Hex[3.4]	Hex[2.7]	Hex[3.4]
Platform [Fixture Dia.]	Ø4.1 [Ø3.5 / Ø4.0 / Ø4.5]	Ø5.1 [Ø5.0 / Ø6.0]	Ø4.1 [Ø3.5 / Ø4.0 / Ø4.5]	Ø5.1 [Ø5.0 / Ø6.0]
Diameter (Angle)	Ø5 (15°)	Ø6 (15°)	Ø5 (25°)	Ø6 (25°)
Length / Cuff	8	8	8	8
2	AAR152	AAW152	AAR252	AAW252
3	AAR153	AAW153	AAR253	AAW253
4	AAR154	AAW154	AAR254	AAW254

- > Packing unit: 1 Angulated Abutment + 1 Abutment Screw.
- > For Screw-Cement or Cement Retained Prosthesis.
- > Solution for the anterior esthetic zone.
- > Connected with the Abutment Screw.
- > Tightened with the Hex Driver and Torque Wrench.
- > Tightening torque force: 30N.cm.
- > Fixture level impression.

Temporary Abutment

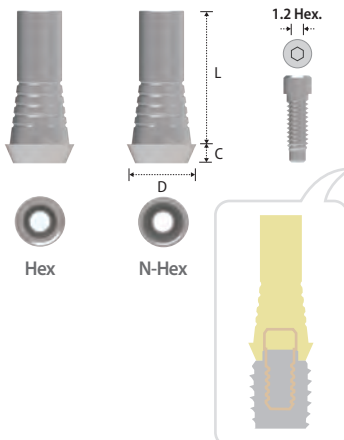

Type[Hex]	Hex[2.7]	Hex[3.4]	N-Hex	N-Hex
Platform [Fixture Dia.]	Ø4.1 [Ø3.5 / Ø4.0 / Ø4.5]	Ø5.1 [Ø5.0 / Ø6.0]	Ø4.1 [Ø3.5 / Ø4.0 / Ø4.5]	Ø5.1 [Ø5.0 / Ø6.0]
Diameter	Ø5.4	Ø5.95	Ø5.4	Ø5.95
Length / Cuff	12	12	12	12
1.5	THR001	THW001	TNR001	TNW001

- > Packing unit: 1 Temporary Abutment + 1 Abutment Screw.
- > For Screw-Cement Retained Prosthesis.
- > For provisional restoration.
- > Connected with the Abutment Screw.
- > Tightened with the Hex Driver and Torque Wrench.
- > Tightening torque force: 20N.cm.

Meta G UCLA Abutment

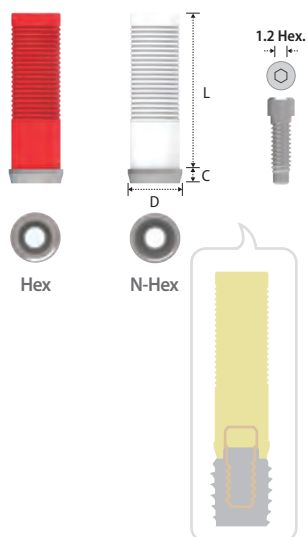

Type[Hex]	Hex[2.7]	Hex[3.4]	N-Hex	N-Hex
Platform [Fixture Dia.]	Ø4.1 [Ø3.5 / Ø4.0 / Ø4.5]	Ø5.1 [Ø5.0 / Ø6.0]	Ø4.1 [Ø3.5 / Ø4.0 / Ø4.5]	Ø5.1 [Ø5.0 / Ø6.0]
Diameter	Ø4.5	Ø5.5	Ø4.5	Ø5.5
Length Cuff	13	13	13	13
1.2	GHR001N	GHW001N	GNR001N	GNW001N

- > Packing unit: 1 Meta G UCLA Abutment + 1 Abutment Screw.
- > For Screw-Cement or Screw Retained Prosthesis.
- > Modification to the angulated abutment, customized abutment and telescopic abutment.
- > CCM alloy core for precise connection.
- > Cast with non-precious metal or gold alloy.
- > Connected with the Abutment Screw.
- > Tightened with the Hex Driver and Torque Wrench.
- > Tightening torque force: 30N.cm.
- > Fixture level impression.

Plastic UCLA Abutment

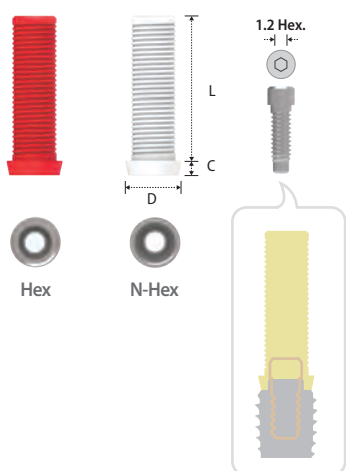

Type[Hex]	Hex[2.7]	Hex[3.4]	N-Hex	N-Hex
Platform [Fixture Dia.]	Ø4.1 [Ø3.5 / Ø4.0 / Ø4.5]	Ø5.1 [Ø5.0 / Ø6.0]	Ø4.1 [Ø3.5 / Ø4.0 / Ø4.5]	Ø5.1 [Ø5.0 / Ø6.0]
Diameter	Ø4.5	Ø5.5	Ø4.5	Ø5.5
Length Cuff	11.8	11.8	11.8	11.8
1.2	PHR001	PHW001	PNR001	PNW001

- > Packing unit: 1 Plastic UCLA Abutment + 1 Abutment Screw.
- > Same purpose of use as Meta G UCLA Abutment but the low accuracy of connection.
- > PMMA material.
- > Connected with the Abutment Screw.
- > Tightened with the Hex Driver and Torque Wrench.
- > Tightening torque force: Finger light force during wax Pattern fabrication, 30N.cm after casting.

Abutment Screw

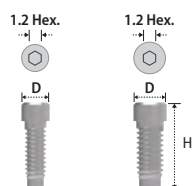

Type[Hex]	Hex[2.7]	Hex[3.4]
Platform [Fixture Dia.]	Ø4.1 [Ø3.5 / Ø4.0 / Ø4.5]	Ø5.1 [Ø5.0 / Ø6.0]
Diameter Height	Ø2.5	Ø3.0
8	SHR100	SHW100

- > Packing unit: 1 Abutment Screw.
- > Tightened with the Hex Driver and Torque Wrench.

Replica



Type[Hex]	Hex[2.7]	Hex[3.4]
Platform [Fixture Dia.]	Ø4.1 [Ø3.5 / Ø4.0 / Ø4.5]	Ø5.1 [Ø5.0 / Ø6.0]
Diameter / Height	Ø4.1	Ø5.1
12	LHR001	LHW001

- > Packing unit: 1 Replica.
- > Mimicking of the conical interface of the fixture.
- > Analog of fixture for the working cast.

Pick-up Squared Impression Coping

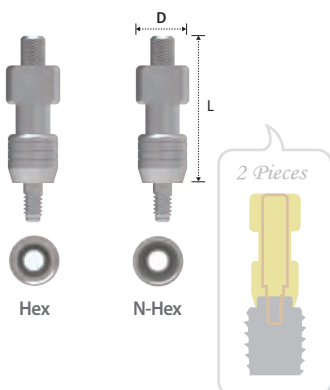

Type[Hex]	Hex[2.7]	Hex[3.4]	N-Hex	N-Hex
Platform [Fixture Dia.]	Ø4.1 [Ø3.5 / Ø4.0 / Ø4.5]	Ø5.1 [Ø5.0 / Ø6.0]	Ø4.1 [Ø3.5 / Ø4.0 / Ø4.5]	Ø5.1 [Ø5.0 / Ø6.0]
Diameter / Length	Ø5.0	Ø5.8	Ø5.0	Ø5.8
17	IHR500	IHW600	INR500	INW600

- > Packing unit: 1 Pick-up Squared Impression Coping + 1 Guide Pin.
- > Connected with the Guide Pin (Regular: UHR115 / Wide: UHW115).
- > For open tray impression.
- > Tightened with the Hex Driver and Torque Wrench.
- > Tightening torque force: 12~15N.cm.

Transfer Post

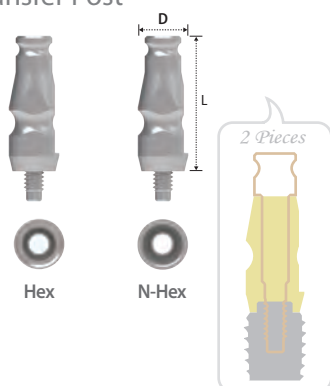

Type[Hex]	Hex[2.7]	Hex[3.4]	N-Hex	N-Hex
Platform [Fixture Dia.]	Ø4.1 [Ø3.5 / Ø4.0 / Ø4.5]	Ø5.1 [Ø5.0 / Ø6.0]	Ø4.1 [Ø3.5 / Ø4.0 / Ø4.5]	Ø5.1 [Ø5.0 / Ø6.0]
Diameter / Length	Ø4.8	Ø5.8	Ø4.8	Ø5.8
13.1	IHR510	IHW610	INR510	INW610

- > Packing unit: 1 Transfer Post + 1 Guide Pin.
- > Connected with the Guide Pin (Regular: IHR510S, IHR610S / Wide: IHW610S).
- > For closed tray impression.
- > Tightened with the Hex Driver and Torque Wrench.
- > Tightening torque force: 12~15N.cm.

Prosthetic Procedure II

Component Selection Guide for Shoulder Abutment

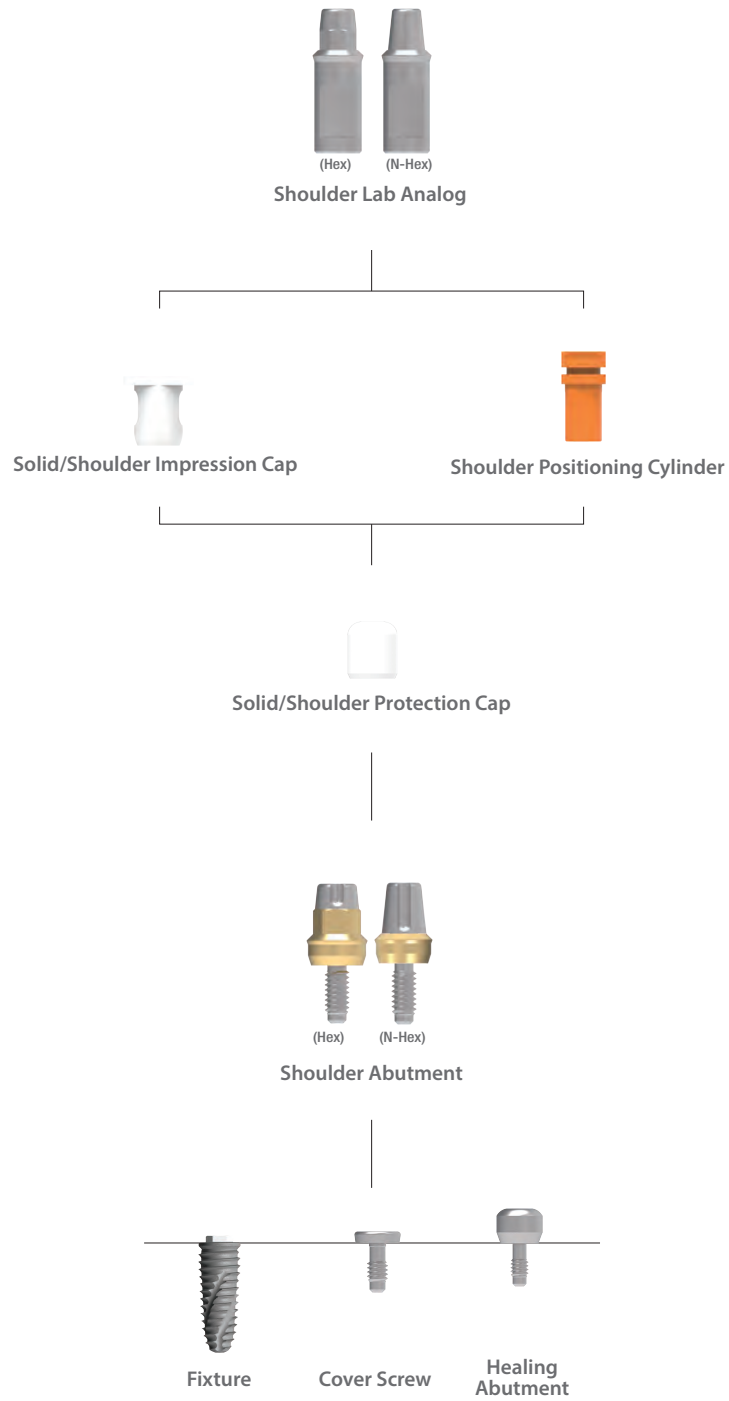

Shoulder Abutment

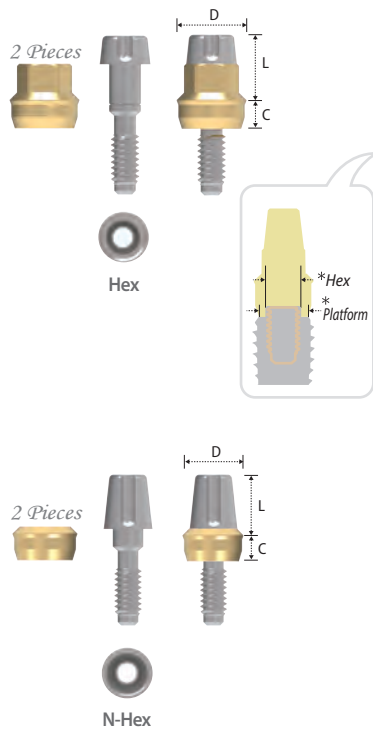

Type[Hex]	Hex[2.7]			Hex[3.4]		
*Platform [Fixture Dia.]	Ø4.1 [Ø3.5 / Ø4.0 / Ø4.5]			Ø5.1 [Ø5.0 / Ø6.0]		
Diameter	Ø4.8			Ø5.9		
Length Cuff	4	5.5	7	4	5.5	7
1	SAC414	SAC415	SAC417	SAC514	SAC515	SAC517
2	SAC424	SAC425	SAC427	SAC524	SAC525	SAC527
3	SAC434	SAC435	SAC437	SAC534	SAC535	SAC537
4	SAC444	SAC445	SAC447	SAC544	SAC545	SAC547

Type[Hex]	N-Hex			N-Hex		
*Platform [Fixture Dia.]	Ø4.1 [Ø3.5 / Ø4.0 / Ø4.5]			Ø5.1 [Ø5.0 / Ø6.0]		
Diameter	Ø4.8			Ø5.9		
Length Cuff	4	5.5	7	4	5.5	7
1	SAB414	SAB415	SAB417	SAB514	SAB515	SAB517
2	SAB424	SAB425	SAB427	SAB524	SAB525	SAB527
3	SAB434	SAB435	SAB437	SAB534	SAB535	SAB537
4	SAB444	SAB445	SAB447	SAB544	SAB545	SAB547

- > Packing unit: 1 Shoulder Abutment.
- > For Cement Retained Prosthesis.
- > Dual anti-rotation grip with a single crown for prevention of screw loosening.
- > Integrated with screw and abutment.
- > Tightened with the Shoulder Ratchet Driver.
- > Tightening torque force: 30N.cm.
- > Abutment level impression: Impression cap in platform Ø4.1 fixture and direct impression in platform Ø5.8 fixture.

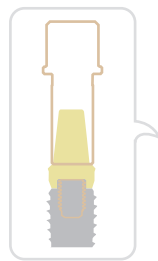

Solid/Shoulder Protection Cap

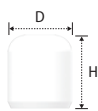

Shoulder Abutment Diameter	Ø4.8	Ø5.9
Diameter	Ø5.4	Ø6.5
Height		
6.2	IASR140	IASW140
7.7	IASR155	IASW155
9.2	IASR170	IASW170

- > Packing unit: 1 Solid/Shoulder Protection Cap.
- > Protection from cheek and tongue for gingival healing period.
- > Alternative usage for sub-structure of the temporary prosthesis.

Solid/Shoulder Impression Cap



Shoulder Abutment Diameter	Ø4.8	Ø5.9
Diameter	8	9
Height	8	9
	IICR001	IICW001

- > Packing unit: 1 Solid/Shoulder Impression Cap.
- > Connected with the Shoulder Positioning Cylinder.
- > Confirm locking with abutment by rotation of clockwise and anti-clockwise direction.

Shoulder Positioning Cylinder



Shoulder Abutment Diameter	Ø4.8	Ø5.9
Diameter	Ø4.4	Ø5.5
Height	10.7	10.7
	SAPR001	SAPW001

- > Packing unit: 1 Shoulder Positioning Cylinder.
- > Inner cutting surface for anti-rotation on the abutment.
- > Insert into the Impression Cap.

Shoulder Lab Analog

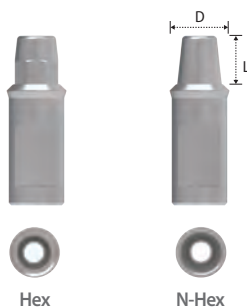

Type[Hex]	Hex[2.7&3.4]		N-Hex	
Shoulder Abutment Diameter	Ø4.8	Ø5.9	Ø4.8	Ø5.9
Diameter	Ø4.8	Ø5.9	Ø4.8	Ø5.9
Length	4	5.5	7	7
	SLCR040	SLCW040	SLBR040	SLBW040
	SLCR055	SLCW055	SLBR055	SLBW055
	SLCR070	SLCW070	SLBR070	SLBW070

- > Packing unit: 1 Shoulder Lab Analog.
- > Replacement of abutment shape in working cast.
- > Choose according to width and length of the abutment.

Prosthetic Procedure III

Component Selection Guide for Ball Abutment

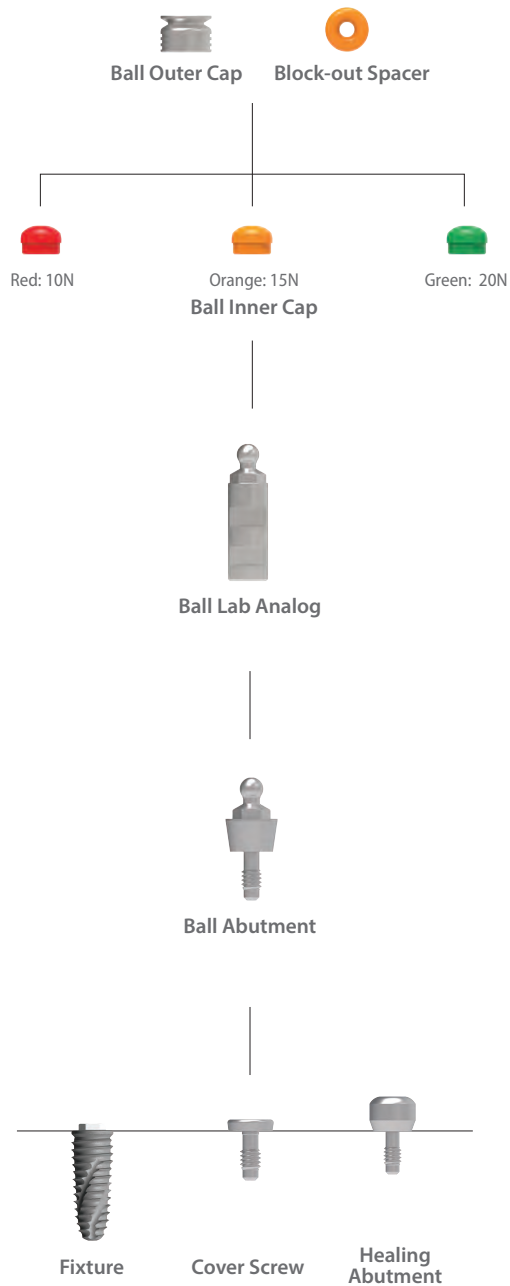

Ball Abutment

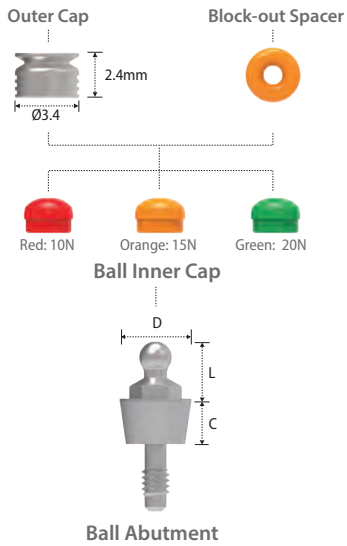

Diameter	Ø5.0	Ø6.0
Length	4	4
1	EBAT411R	EBAT511R
2	EBAT412R	EBAT512R
3	EBAT413R	EBAT513R
4	EBAT414R	EBAT514R

- > Packing unit: 1 Ball Abutment + 3 Inner Caps (1 per each color) + 1 Block-out Spacer + 1 Outer Cap.
- > For Implant-Supported Overdenture Prosthesis.
- > Tightened with the Ball Ratchet Driver and Torque Wrench.
- > Tightening torque force: 30N.cm.
- > Direct impression.

Ball Outer Cap

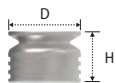

Diameter	Ø3.4
Height	2.4

- > Packing unit: 2 Outer Caps.

Ball Inner Cap

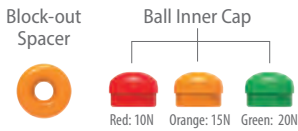

BATC003I	
----------	--

- > Packing unit: 2 Block-out Spacers + 6 Inner Caps (2 per each color).
- > Retention force: Red 10N, Orange 15N & Green 20N.

Ball Lab Analog



Diameter	Ø4.0
Length	4

- > Packing unit: 4 Ball Lab Analogs.
- > Replacement of abutment shape in working cast.

Ball Ratchet Driver

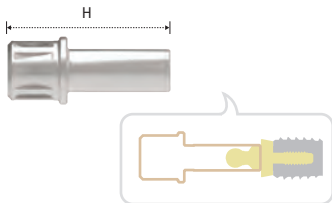

Type	Ratchet
Height	19

- > Packing unit: 1 Ball Ratchet Driver. *Extra Product
- > To install and remove the Ball Abutment with the Torque Wrench.

Ball I&R Driver

Height	100
KBIR01	

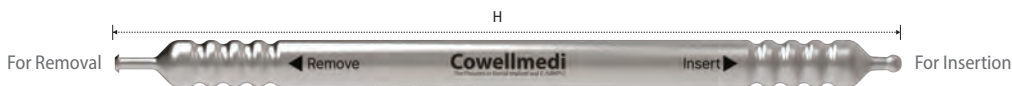

- > Packing unit: 1 Ball I&R Driver.
- > Used to insert and remove the Inner Caps into and out of the Outer Cap.

Mini Plus Implant system

Mini Plus Implant

Cement Type

Ball Type

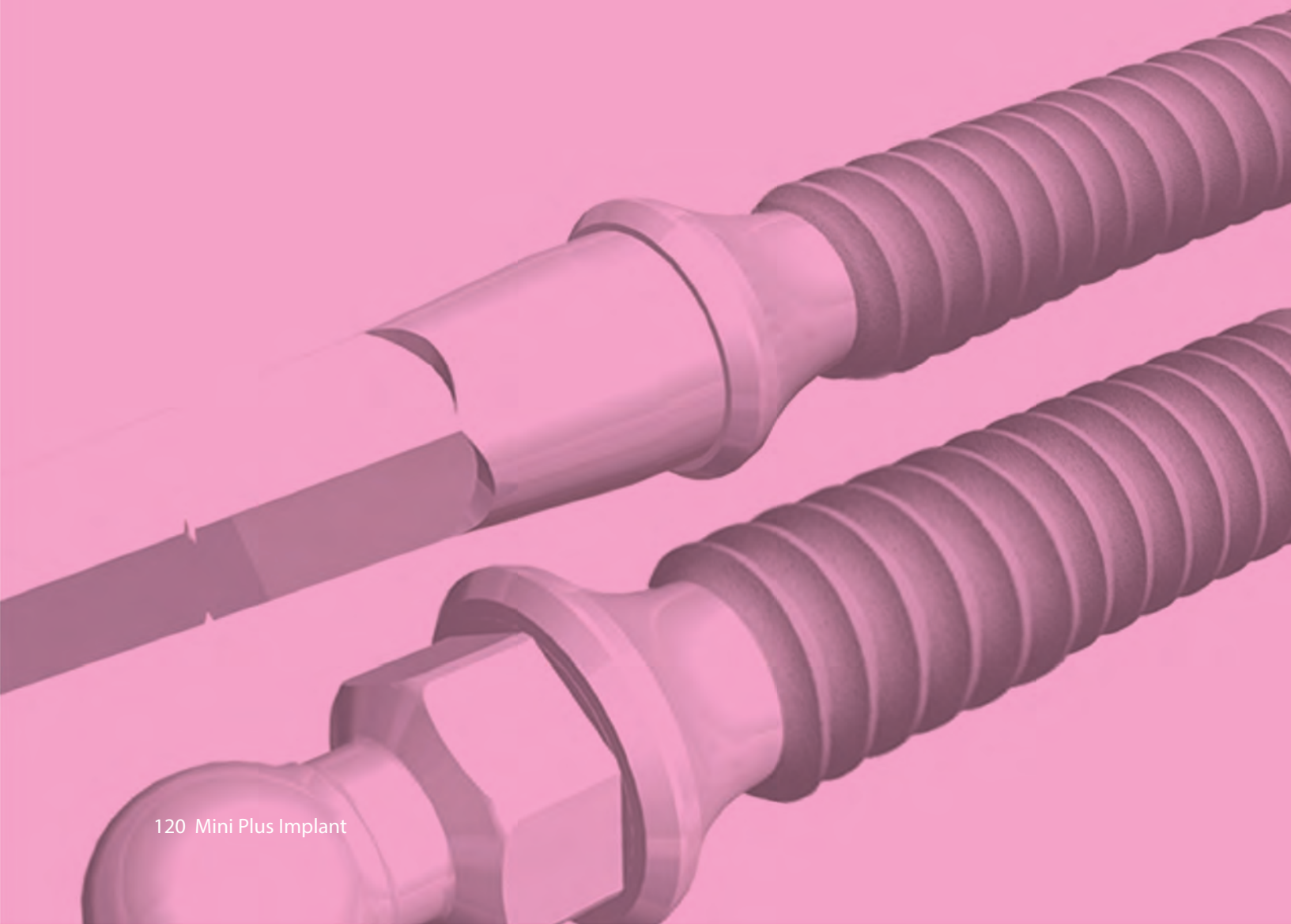

Mini Plus Implant System

DESIGN OF MINI PLUS FIXTURE (1P-C.)

Cement Type

- > For mandible anterior spaces and edentulous arch.
- > For semi-permanent or temporary solution.

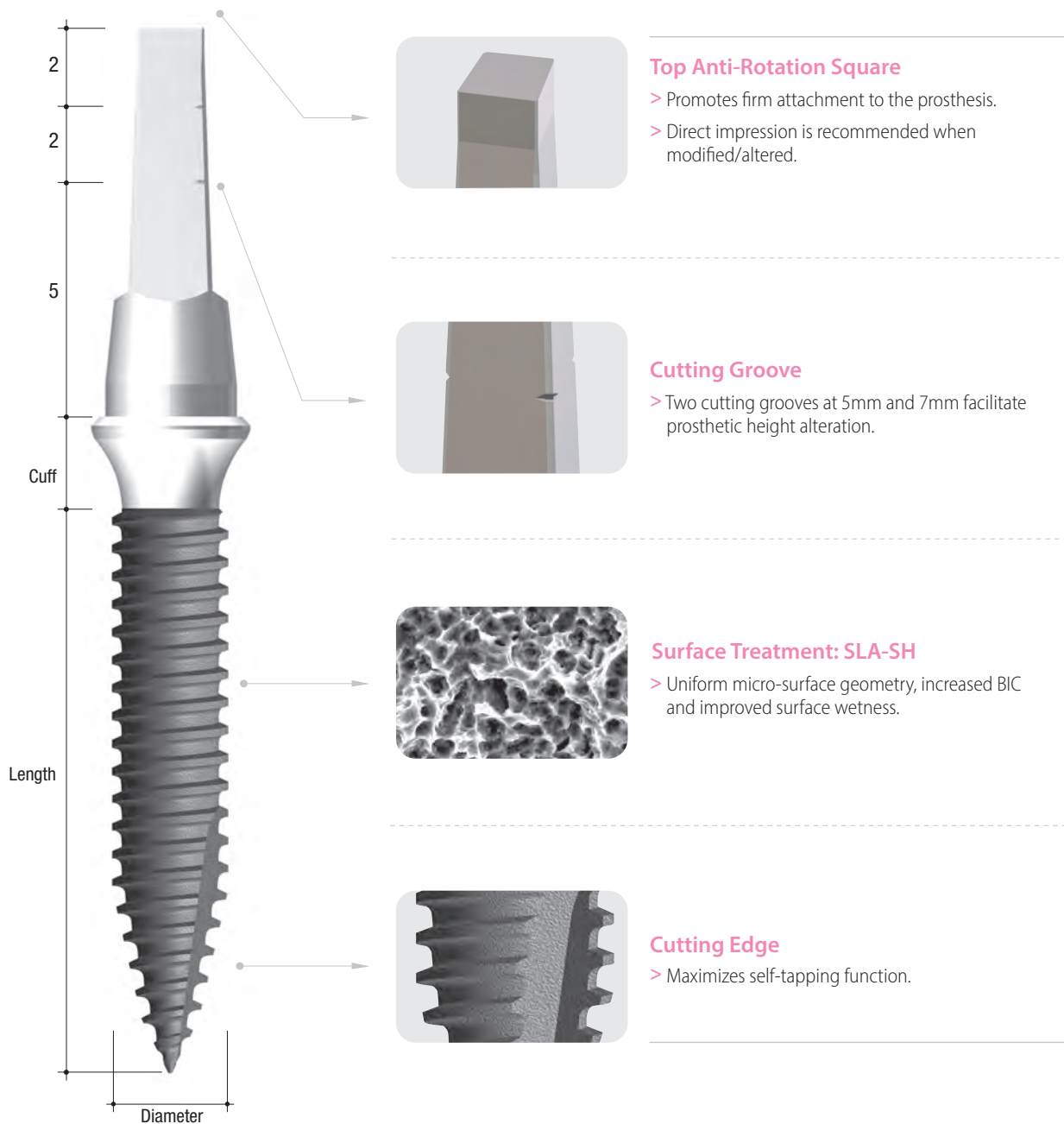

System Flow

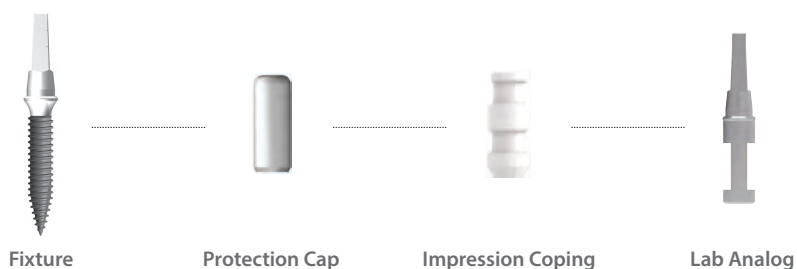

Fixture



Diameter		Ø2.5	
Length	Cuff	2.0mm	4.0mm
10mm		AMC2210S	AMC2410S
12mm		AMC2212S	AMC2412S
14mm		AMC2214S	AMC2414S

- > Packing unit: 1 Fixture.
- > Abutment level impression.



Diameter		Ø3.0	
Length	Cuff	2.0mm	4.0mm
10mm		AMC3210S	AMC3410S
12mm		AMC3212S	AMC3412S
14mm		AMC3214S	AMC3414S

- > Packing unit: 1 Fixture.
- > Abutment level impression.

Impression Coping / Lab Analog

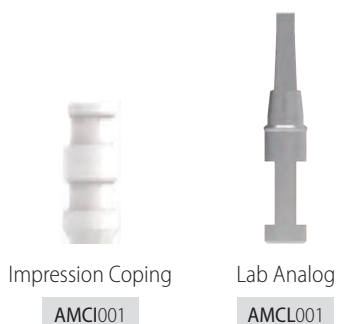

Impression Coping

- > Packing unit: 1 Impression Coping.
- > Used for impression taking of the post of the fixture.
- > Direct impression is recommended when modified/alterd.

Lab Analog

- > Packing unit: 1 Lab Analog.
- > The same adjustment must be made for the Lab Analog when the abutment portion of the fixture is modified/alterd.
- > Replacement of the cement post shape in working cast.

Protection Cap

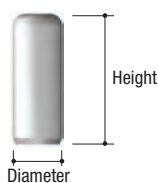

Diameter / Height	Ø4.0
7mm	AMCC001
9mm	AMCC002
11mm	AMCC003

- > Packing unit: 1 Protection Cap.
- > Provides temporary protection from mucosa, gingiva, and tongue after implantation.

DESIGN OF MINI PLUS FIXTURE (1P-B.)

Ball Type

> For semi-permanent or temporary solution for overdenture prosthesis.



System Flow

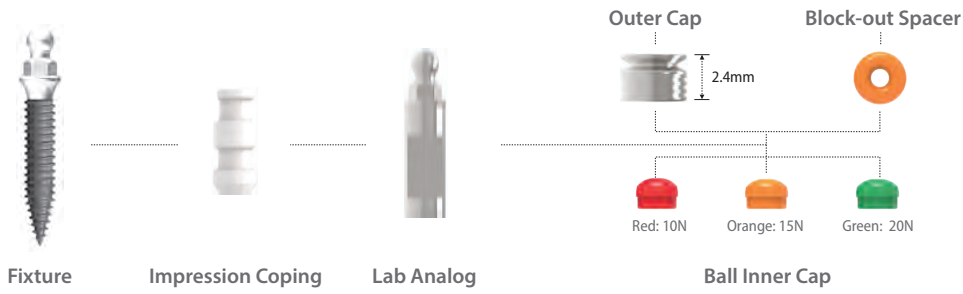

Fixture



Diameter		Ø2.5	
Length	Cuff	2.0mm	4.0mm
10mm		AMB2210S	AMB2410S
12mm		AMB2212S	AMB2412S
14mm		AMB2214S	AMB2414S

> Packing unit: 1 Fixture.



Diameter		Ø3.0	
Length	Cuff	2.0mm	4.0mm
10mm		AMB3210S	AMB3410S
12mm		AMB3212S	AMB3412S
14mm		AMB3214S	AMB3414S

> Packing unit: 1 Fixture.

Ball Outer Cap

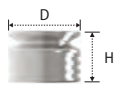

Diameter Height	Ø3.4
2.4	BATC003C

> Packing unit: 2 Outer Caps.

Ball Inner Cap

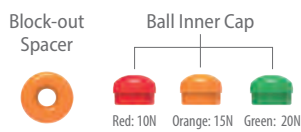

Code
BATC003I

> Packing unit: 2 Block-out Spacers + 6 Inner Caps (2 per each color).
> Retention force: Red 10N, Orange 15N & Green 20N.

Impression Coping / Lab Analog

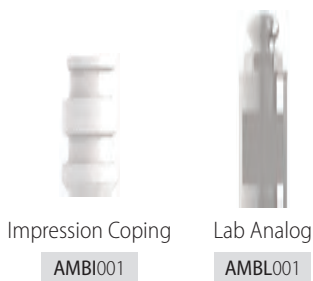

Impression Coping

> Packing unit: 1 Impression Coping.
> Used for impression taking of the post of the fixture.

Lab Analog

> Packing unit: 1 Lab Analog.
> Replacement of the ball post shape in working cast.